

# Ontario VOR





# TABLE OF CONTENTS

## SEATING

### TASK CHAIRS | TASK STOOLS

- [Knoll](#)

### SIDE | GUEST | MEETING

- [Knoll](#)
- [Krug](#)
- [Norix](#)
- [Spec](#)

### LOUNGE | SOFT SEATING

- [Knoll](#)
- [Krug](#)
- [Norix](#)
- [Spec](#)

## CLASSICS

- [Knoll](#)

## STORAGE

- [Knoll](#)

## FREESTANDING & SYSTEMS FURNITURE

### FREESTANDING

- [Knoll](#)

### SYSTEMS

- [Knoll](#)

### BENCHING

- [Knoll](#)

## ERGONOMIC ACCESSORIES

- [Humanscale](#)

## TABLES

- [Knoll](#)

## WHITEBOARDS

- [ASI](#)

## HD STORAGE

- [SpaceSaver](#)

## OUTDOOR

- [Canaan Site Furnishings](#)

## ARCHITECTURAL WALLS

- [MyWall](#)



Click to Navigate



# Task Chairs | Task Stools

## Knoll: Remix, mid back



### Sustainability | Compliance:

BIFMA Level®, Clean Air Gold, Declare, can contribute to LEED® credits



Declare.



### Warranty:

12 Years, 3 years for upholstery



[Click here for product brochure](#)

[Click here for product price list](#)

### Description:

Remix combines both innovative and traditional elements, resulting in a new performance for the classic upholstered chair. It features a Tandem Back™ which delivers immediate, plush comfort paired with Flex Net Matrix™ technology that provides resiliency, flexibility and support. Adjustable tilt tension and a three-point tilt lock offer personalized fit and a deep dwell.

### Specifications:

- + Tandem back provides movement and support
- + Contoured seat with waterfall edge
- + Standard intuitive adjustments for seat height and depth
- + Three-point tilt lock and tilt tension
- + Height adjustable arms standard, high performance arms available

### Dimensions:

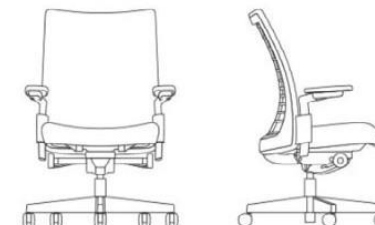

\*with standard cylinder.  
Low (-1.4") and High (+1.3")  
cylinder available.

w	d	h	seat h	arm h
30"	23.5" (excluding base)	36.9-44.9"	16.6-21.5"	26.3-31.3"

### Finishes:

Flex Net Matrix:

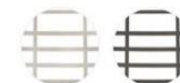

Pebble Storm

B Side Textile:



Pebble Storm

Base:



Black Polished Aluminum

### Fabrics:

[Click here for approved Textiles](#)

[Click here to view Textiles](#)



# Knoll: Regeneration



## Sustainability | Compliance:

BIFMA Level®, Clean Air Gold, can contribute to LEEDS® credits



## Warranty:

12 Years, 3 years for upholstery



[Click here for product brochure](#)

[Click here for product price list](#)

## Description:

ReGeneration by Knoll is innovative in its simplicity, minimizing materials and components. Its straightforward design leverages flexible and durable materials that respond to your movements, providing comfort and support throughout the day without interrupting your workflow.

## Specifications:

- + High-performance elastomer suspension back
- + Integrally coloured arms, self skinning Polyurethane
- + High-resiliency molded biobase foam set with sewn textile cover and integrally coloured, glass reinforced, impact modified nylon seat structure
- + Five-star design, hard and soft casters available

## Dimensions:

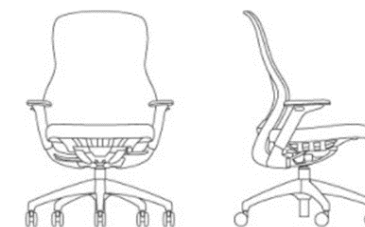

\*with standard cylinder.  
Low (-1.4") and High (+1.6")  
cylinder available.

w	d	h	seat h	arm h
29"	24.6" (excluding base)	38.1- 43.3"	16.4-21.3"	22.5-31.9"

## Finishes:

### Flex Back:



### Base:

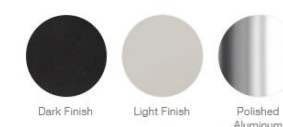

### Frame:

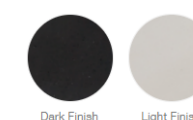

## Fabrics:

[Click here for approved Textiles](#)

[Click here to view Textiles](#)

## Knoll: Regeneration, high task



### Sustainability | Compliance:

BIFMA Level®, Clean Air Gold, can contribute to LEEDS® credits



### Warranty:

12 Years, 3 years for upholstery



[Click here for product brochure](#)

[Click here for product price list](#)

### Description:

ReGeneration by Knoll is innovative in its simplicity, minimizing materials and components. Its straightforward design leverages flexible and durable materials that respond to your movements, providing comfort and support throughout the day without interrupting your workflow.

### Specifications:

- + High-performance elastomer suspension back
- + Integrally coloured arms, self skinning Polyurethane
- + High-resiliency molded biobase foam set with sewn textile cover and integrally coloured, glass reinforced, impact modified nylon seat structure
- + Five-star design, hard and soft casters available

### Dimensions:

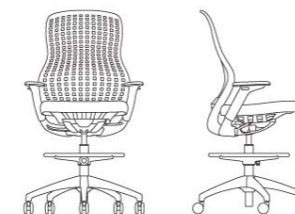

w	d	h*	seat h*	arm h*
29"	24.6" (excluding base)	43.5-52.3"	22-30.8"	27.9-40.7"

### Finishes:

#### Flex Back:



#### Base:

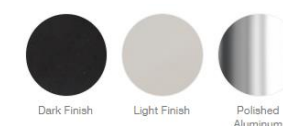

#### Frame:

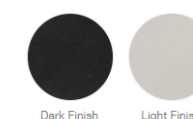

### Fabrics:

[Click here for approved Textiles](#)

[Click here to view Textiles](#)



# Knoll: Generation



## Sustainability | Compliance:

BIFMA Level®, Clean Air Gold, can contribute to LEEDS® credits



## Warranty:

12 Years, 3 years for upholstery



[Click here for product brochure](#)

[Click here for product price list](#)

## Description:

Since its introduction in 2009, Generation has redefined seating by replacing the notions of how people “should” sit with the support users' need to work freely. The first chair to promote unrestrained movement, Generation is a true reflection of innovation and thoughtful design.

## Specifications:

- + The Flex Back fuses two innovative elements — the high performance elastomer Flex Back Net and a distinctive figure 8 structure — which together support many different postures and allow for multidimensional movement throughout the workday.
- + The Continuous Lumbar carries the lumbar support in the Flex Back through the design of the arms.

## Dimensions:

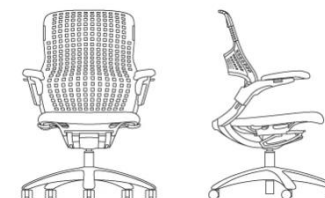

\*with standard cylinder.  
Low (-1.4”) and High (+1.6”) cylinder available.

w	d	h	seat h	arm h
28.5”	26” (excluding base)	39.25-44.5”	16.5-21.75”	22.75-32.5”

## Finishes:

Base:

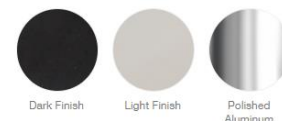

Frame:

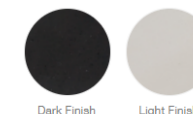

[Click here for flex back options](#)

## Fabrics:

[Click here for approved Textiles](#)

[Click here to view Textiles](#)

# Knoll: K.Task

[Click here for product brochure](#)

[Click here for product price list](#)



### Description:

k. task is a highly adjustable, highly affordable work chair well-suited for the demands of today's workplace. The double-layer mesh back and cushioned seat offer lasting comfort, while the simple aesthetic adapts to any environment.

### Specifications:

- + SYNCHRONIZED TILT TENSION CONTROL. Provides a smooth, easy recline with only one turn of the dial
- + FIVE-POINT TILT LOCK. Allows you to set the chair upright or reclined, depending on the task
- + WATERFALL SEAT EDGE. Allows for unrestricted movement to support various postures

### Dimensions:



\*with standard cylinder.  
Low (-1.4") and High (+1.6")  
cylinder available.

w	d	h	seat h	arm h
27"	27" (excluding base)	37.9-43.2"	15.6-20.9"	23.3-31.7"

### Sustainability | Compliance:

Clean Air Gold



### Warranty:

12 Years, 3 years for upholstery



### Finishes:

#### Mesh:



Black



Grey

#### Base:



Black



Polished Aluminum

### Fabrics:



Delite - Red

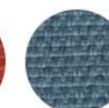

Delite - Turquoise

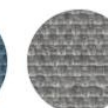

Delite - Gray

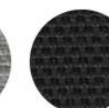

Delite - Onyx



Black Faux Leather



## Knoll: Olo, knit back



[Click here for product brochure](#)

[Click here for product price list](#)

### Description:

Olo with knit back is designed to keep you engaged while supporting your spontaneous work style – combining material and technical innovation to make the perfect chair for working wherever you are. Olo with knit back ensures comfort and straightforward performance all while keeping you cool under pressure.

### Specifications:

- + The proprietary knit pattern creates an even and resilient tension flexes with your everyday movements
- + The Active Pivot control creates a smooth, effortless recline without any manual adjustments, dynamically responding to your movements

### Dimensions:



	w	d	h*	seat h*	arm h from seat
with arms	25.5"	20.9"	35 - 40.3"	15.1"	9.1"
armless	21.3"	20.9"	35 - 40.3"	17"	

### Sustainability | Compliance:

BIFMA Level®, Clean Air GOLD, Declare



Declare.

### Warranty:

12 Years, 3 years for upholstery



### Finishes:

#### O Knit:



#### Base:



### Fabrics:

[Click here for approved Textiles](#)

[Click here to view Textiles](#)

# Knoll: Olo, shell back

[Click here for product brochure](#)

[Click here for product price list](#)



### Description:

Olo with shell back is designed to stay on pace with the spontaneous style of today's work – pivoting between people, locations and tasks without breaking stride. Olo is a chair everyone can get comfortable in. Straightforward, streamlined performance ensures Olo is always ready for you so that you can be ready for anything.

### Specifications:

- + The lower back is more structured, providing lumbar support and control, while the upper back flexes with your movements.
- + The Active Pivot control creates a smooth, effortless recline without any manual adjustments, dynamically responding to your movements

### Dimensions:



	w	d	h*	seat h*	arm h from seat
with arms	25.14"	23"	31.75 - 36.95"	16 - 21.2"	8.5"
armless	23.5"	23"	31.75 - 36.95"	16 - 21.2"	

### Sustainability | Compliance:

BIFMA Level®, Clean Air GOLD, Declare



### Warranty:

12 Years, 3 years for upholstery



### Finishes:

Upper Back:



Light Grey Medium Grey Black

Upper Back:

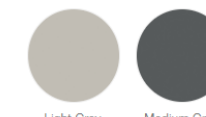

Light Grey Medium Grey

Base:



Light Grey Medium Grey

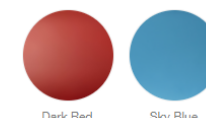

Dark Red Sky Blue



Black

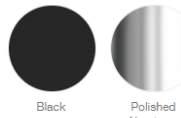

Black Polished Aluminum

### Fabrics:

[Click here for approved Textiles](#)

[Click here to view Textiles](#)



## Knoll: Olo, knit back stool



### Sustainability | Compliance:

BIFMA Level®, Clean Air GOLD, Declare



### Warranty:

12 Years, 3 years for upholstery



[Click here for product brochure](#)

[Click here for product price list](#)

### Description:

Olo with knit back is designed to keep you engaged while supporting your spontaneous work style – combining material and technical innovation to make the perfect chair for working wherever you are. Olo with knit back ensures comfort and straightforward performance all while keeping you cool under pressure.

### Specifications:

- + The proprietary knit pattern creates an even and resilient tension flexes with your everyday movements
- + The Active Pivot control creates a smooth, effortless recline without any manual adjustments, dynamically responding to your movements

### Dimensions:



	w	d	h
with arms	25.5"	20.9"	41.5 - 49.9"
armless	21.3"	20.9"	41.5 - 49.9"

### Finishes:

#### O Knit:



#### Base:



### Fabrics:

[Click here for approved Textiles](#)

[Click here to view Textiles](#)

# Knoll: Multigeneration, hybrid base



**Sustainability | Compliance:**

BIFMA Level®, Clean Air GOLD, Declare



**Warranty:**

12 Years, 3 years for upholstery



[Click here for product brochure](#)

[Click here for product price list](#)

**Description:**

MultiGeneration by Knoll® encourages collaboration with a responsive, open design that supports multiple postures and a diversity of people in shared, team and large group environments. MultiGeneration encourages natural movement, allowing us to focus, interact and communicate more effectively.

**Specifications:**

- + Full, curved back allows for upper body movement and supports the lower back for upright, interactive postures
- + Gently contoured seat with rounded edges
- + Cantilevered arms feature contoured arm pads
- + Perforated back provides airflow

**Dimensions:**

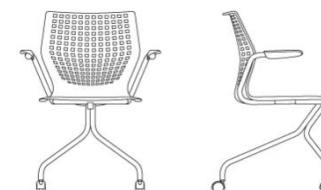

	w	d	h	seat h*	arm h
with arms	25.6"	21.9"	33.9"	17.3"	26.9"
armless	20.5"	21.9"	33.9"	17.3"	

**Finishes:**

**Back:**



**Frame:**



**Fabrics:**

[Click here for approved Textiles](#)

[Click here to view Textiles](#)

## Knoll: Multigeneration, light task



### Sustainability | Compliance:

BIFMA Level®, Clean Air GOLD, Declare



### Warranty:

12 Years, 3 years for upholstery



[Click here for product brochure](#)

[Click here for product price list](#)

### Description:

MultiGeneration by Knoll® encourages collaboration with a responsive, open design that supports multiple postures and a diversity of people in shared, team and large group environments. MultiGeneration encourages natural movement, allowing us to focus, interact and communicate more effectively.

### Specifications:

- + Full, curved back allows for upper body movement and supports the lower back for upright, interactive postures
- + Gently contoured seat with rounded edges
- + Cantilevered arms feature contoured arm pads
- + Perforated back provides airflow

### Dimensions:

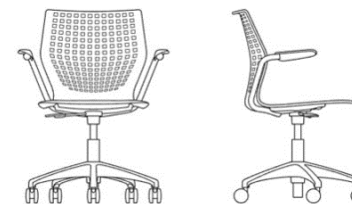

	w	d	h	seat h*	arm h from seat
with arms	25.6"	21.9"	31 - 37.5"	16.1 - 22.24"	9.1"
armless	20.5"	21.9"	31 - 37.5"	16.1 - 22.24"	

### Finishes:

#### Back:



#### Frame:



### Fabrics:

[Click here for approved Textiles](#)

[Click here to view Textiles](#)



# Knoll: Multigeneration, high task



[Click here for product brochure](#)

[Click here for product price list](#)

### Description:

MultiGeneration by Knoll® encourages collaboration with a responsive, open design that supports multiple postures and a diversity of people in shared, team and large group environments. MultiGeneration encourages natural movement, allowing us to focus, interact and communicate more effectively.

### Specifications:

- + Full, curved back allows for upper body movement and supports the lower back for upright, interactive postures
- + Gently contoured seat with rounded edges
- + Cantilevered arms feature contoured arm pads
- + Perforated back provides airflow

### Dimensions:

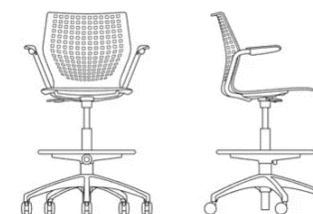

	w	d	h	seat h*	arm h from seat
with arms	27"	27"	38 - 48"	22.7 - 33"	9.1"
armless	27"	27"	38 - 48"	22.7 - 33"	

### Sustainability | Compliance:

BIFMA Level®, Clean Air GOLD, Declare



### Warranty:

12 Years, 3 years for upholstery

### Finishes:

#### Back:



#### Frame:



### Fabrics:

[Click here for approved Textiles](#)

[Click here to view Textiles](#)

## Knoll: Olo, shell back stool



### Sustainability | Compliance:

BIFMA Level®, Clean Air GOLD, Declare



### Warranty:

12 Years, 3 years for upholstery



[Click here for product brochure](#)

[Click here for product price list](#)

### Description:

Olo with shell back is designed to stay on pace with the spontaneous style of today's work – pivoting between people, locations and tasks without breaking stride. Olo is a chair everyone can get comfortable in. Straightforward, streamlined performance ensures Olo is always ready for you so that you can be ready for anything.

### Specifications:

- + The lower back is more structured, providing lumbar support and control, while the upper back flexes with your movements.
- + The Active Pivot control creates a smooth, effortless recline without any manual adjustments, dynamically responding to your movements

### Dimensions:



	w	d	h*	seat h*	arm h from seat
with arms	25.14"	23"	31.75 - 36.95"	16 - 21.2"	8.5"
armless	23.5"	23"	31.75 - 36.95"	16 - 21.2"	

### Finishes:

Upper Back:



Light Grey Medium Grey Black

Upper Back:

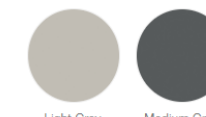

Light Grey Medium Grey

Base:



Light Grey Medium Grey

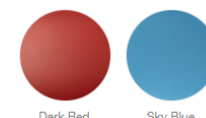

Dark Red Sky Blue



Black

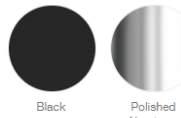

Black Polished Aluminum

### Fabrics:

[Click here for approved Textiles](#)

[Click here to view Textiles](#)

# Knoll: Life



[Click here for product brochure](#)

[Click here for product price list](#)

### Description:

With intuitive adjustments, a slim silhouette and a broad color and finish palette, Life sets the standard for ergonomics and innovative design. The advanced control automatically adjusts to the weight of your body, providing personalized and effortless ergonomic support.

### Specifications:

- + Synchronized recline mechanism with auto-balanced tension.
- + Flexing seat pan alleviates pressure points, allows for proper circulation, supports perched postures
- + Exclusive elastomeric knit that is soft, resilient and durable.

### Dimensions:



w	d	h*	seat h*	arm h*
26.5"	24.5"	38.5 - 43.75"	15.75- 21"	22-31.5"

### Sustainability | Compliance:

BIFMA Level®



### Warranty:

12 Years, 3 years for upholstery



### Finishes:

#### Back Suspension Fabric:



### Fabrics:

[Click here for approved Textiles](#)

[Click here to view Textiles](#)



A modern meeting room with large windows, a round table, and three people (two women and one man) engaged in a meeting. The room features contemporary decor, including a large TV on the wall and modern chairs. A semi-transparent blue banner is overlaid across the middle of the image, containing the text "Side | Guest | Meeting".

Side | Guest | Meeting



## Knoll: Remix, high back



[Click here for product brochure](#)

[Click here for product price list](#)

### Description:

Remix combines both innovative and traditional elements, resulting in a new performance for the classic upholstered chair. It features a Tandem Back™ which delivers immediate, plush comfort paired with Flex Net Matrix™ technology that provides resiliency, flexibility and support. Adjustable tilt tension and a three-point tilt lock offer personalized fit and a deep dwell.

### Specifications:

- + Tandem back provides movement and support
- + Contoured seat with waterfall edge
- + Standard intuitive adjustments for seat height and depth
- + Three-point tilt lock and tilt tension
- + Height adjustable arms standard, high performance arms available

### Dimensions:

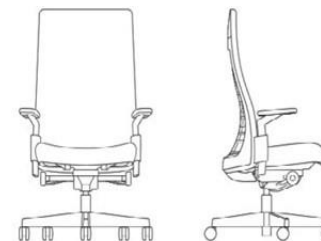

\*with standard cylinder.  
Low (-1.4") and High (+1.3")  
cylinder available.

w	d	h	seat h	arm h
30"	23.5" (excluding base)	43.4-51.3"	16.6-21.5"	26.3-31.3"

### Sustainability | Compliance:

BIFMA Level®, Clean Air Gold, Declare, can contribute to LEEDS® credits



Declare.



### Warranty:

12 Years, 3 years for upholstery

### Finishes:

Flex Net Matrix:



Pebble Storm

B Side Textile:



Pebble Storm

Base:



Black Polished Aluminum

### Fabrics:

[Click here for approved Textiles](#)

[Click here to view Textiles](#)

# Knoll: Remix, side chair

[Click here for product brochure](#)

[Click here for product price list](#)



**Description:** The perfect complement to Remix Work and High Back chairs, Remix Side offers responsiveness for various work modes while satisfying a traditional aesthetic. It pairs cushioning for immediate comfort with resilient yet pliable flexors to provide an unexpected amount of back flex.

- Specifications:**
- + Plush cushioning provides immediate comfort
  - + Pliable flexors, enables back movement
  - + Fully upholstered perimeter, offers soft, uninterrupted comfort for movement throughout the day

**Dimensions:**



w	d	h	seat h	arm h
23"	22.4"	31.5"	17.7"	26"

**Sustainability | Compliance:**

Clean Air Gold, can contribute to LEEDS® credits



**Warranty:** 12 Years, 3 years for upholstery

**Finishes:**

Base:

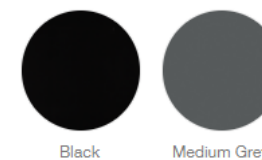

**Fabrics:**

[Click here for approved Textiles](#)

[Click here to view Textiles](#)



# Knoll: Multigeneration, stacking



**Sustainability | Compliance:**

BIFMA Level®, Clean Air GOLD, Declare



**Warranty:**

12 Years, 3 years for upholstery



[Click here for product brochure](#)

[Click here for product price list](#)

**Description:**

MultiGeneration by Knoll® encourages collaboration with a responsive, open design that supports multiple postures and a diversity of people in shared, team and large group environments. MultiGeneration encourages natural movement, allowing us to focus, interact and communicate more effectively.

**Specifications:**

- + Full, curved back allows for upper body movement and supports the lower back for upright, interactive postures
- + Gently contoured seat with rounded
- + Cantilevered arms feature contoured arm pads
- + Perforated back provides airflow

**Dimensions:**

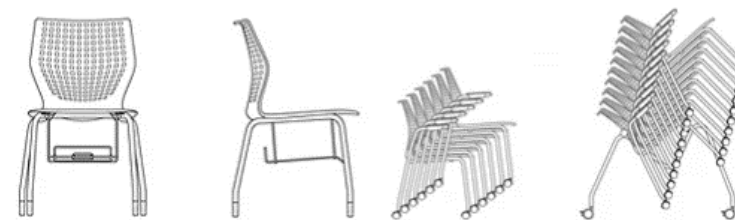

	w	d	h	seat h	arm h
with Fixed Arms	25.6"	21.4"	33.6"	17.3"	26.8"
Armless	21.6"	21.4"	33.6"	17.3"	

**Finishes:**

Back:



Frame:



**Fabrics:**

[Click here for approved Textiles](#)

[Click here to view Textiles](#)

# Knoll: Multigeneration, bar stool



[Click here for product brochure](#)

[Click here for product price list](#)

## Description:

MultiGeneration by Knoll® encourages collaboration with a responsive, open design that supports multiple postures and a diversity of people in shared, team and large group environments. MultiGeneration encourages natural movement, allowing us to focus, interact and communicate more effectively.

## Specifications:

- + Open design allows for 270° sitting, perfect for collaborative, group environments
- + Perforated back provides airflow, optional seat pad
- + The top edge serves as an armrest when side sitting, or handle for transporting
- + The footrest allows for various positions while still being supported

## Dimensions:



	w	d	h	seat h*
bar height	18.6"	23.4"	44.5"	29.5"
counter height	18.6"	23.4"	41.7"	26.7"

## Sustainability | Compliance:

BIFMA Level®, Clean Air GOLD, Declare



## Warranty:

12 Years, 3 years for upholstery



## Finishes:

### Back:



### Frame:



## Fabrics:

[Click here for approved Textiles](#)

[Click here to view Textiles](#)

# Knoll: Moment



[Click here for product brochure](#)

[Click here for product price list](#)

### Description:

Taking its cue from the cantilevered form of the classic Tubular Brno chair by Ludwig Mies van der Rohe, Moment is a practical solution for the guest chair that most offices require. Moment complements our diverse portfolio of office seating and furniture with its pure expression of the cantilevered form.

### Specifications:

- + Sled base that stacks 4 high on floor
- + Finished underside of seat protects upholstery when stacked
- + Textured, contoured back cleaves the tubular frame with no visible fasteners

### Dimensions:



w	d	h	seat h	arm h
21"	21"	32.5"	17.75"	26.25"

### Sustainability | Compliance:

BIFMA Level®, Clean Air GOLD



### Warranty:

12 Years, 3 years for upholstery

### Finishes:

Back:



Almost Black    Charcoal    White

Frame:



Metallic Silver - frame    Metallic Grey - frame    Black    Trivalent Chrome - frame

### Fabrics:

[Click here for approved Textiles](#)

[Click here to view Textiles](#)



## Krug: Aqua, conference chair adjustable arms



### Sustainability | Compliance:

BIFMA e3 & Air Emissions Certified



### Warranty:

Limited Lifetime



[Click here for product brochure](#)

[Click here for product price list](#)

### Description:

Extensively researched, Aqua features unique proportions and contouring that make it light and small-scaled in exterior footprint but spacious and exceptionally comfortable on the inside. Virtually all major components of Aqua can be field replaced.

### Specifications:

- Back: Unique mesh suspension core covered in healthcare approved coated textile.
- Arms: Glass-filled nylon arm support with polyurethane height, width and rotationally adjustable arm pad.
- Seat: Plywood base with molded foam.
- Base: Glass-filled nylon.
- Hard casters or soft casters available.
- Extras: Includes sealed seams & underside for moisture barrier and bedbug prevention.
- Weight capacity: 300 lbs.

### Dimensions:

W	D	H	seat h	arm h
26.5"	23"	38.8-42.7"	17.3-21.7"	25.5-30"

### Finishes:

Base:



Black

Polished Aluminum  
\*Upcharge

### Fabrics:

[Click here to view Textiles](#)

## Krug: C5, conference chair fixed arms



### Sustainability | Compliance:

BIFMA e3 & Air Emissions Certified



### Warranty:

Limited Lifetime



[Click here for product brochure](#)

[Click here for product price list](#)

### Description:

Sleek and contemporary, C5 is lightly scaled with contoured upholstery, ergonomic design and dual-density cushioning to providing optimal seating comfort. Virtually all major components of C5 can be field replaced.

### Specifications:

- Back: Ribbed upholstery detail covered in healthcare approved coated textile.
- Arms: Fixed, black polyurethane arm.
- Seat: Plywood base with dual density molded foam.
- Base: Glass-filled nylon.
- Hard casters or soft casters available.
- Extras: Includes sealed seams & underside for moisture barrier and bedbug prevention.
- Weight capacity: 300 lbs.

### Dimensions:

W	D	H	seat h	arm h
25"	23.8"	40-43.9"	18.9-22.8"	26.5-30.4"

### Finishes:

Base:



Black

Polished Aluminum  
\*Upcharge

### Fabrics:

[Click here to view Textiles](#)

## Krug: Faeron Metal, side chair



### Sustainability | Compliance:

BIFMA e3 & Air Emissions Certified



### Warranty:

Limited Lifetime



 [Click here for product brochure](#)

 [Click here for product price list](#)

### Description:

Faeron can be specified to perfectly suit a multitude of applications within the same facility. Durable metal frame with clean out. Multi-density foam and spring seat construction provide exceptional seating comfort. Arms available as open, closed, or semi closed with optional solid surface arms. Virtually all major components of Faeron can be field replaced.

### Specifications:

- Back: Contoured and angled for supportive seating, upholstered in healthcare approved coated textile.
- Arms: Fixed polymer arms with upholstered arm panel.
- Seat: Spring seat construction with multi-density molded foam and clean-out.
- Legs: Steel wall saver legs.
- Extras: Includes sealed seams & underside for moisture barrier and bedbug prevention.
- Weight Capacity: 500 lbs.

### Dimensions:

W	D	H	seat h	arm h
25"	26.3"	34.5"	19"	25"

### Finishes:

Base:



Black

Polished  
Aluminum  
\*Upcharge

### Fabrics:

 [Click here to view Textiles](#)



# Krug: Karma, stacking chair with arms



Optional Ganging Brackets



Optional Floor Anchors

**Sustainability | Compliance:**

BIFMA e3 & Air Emissions Certified



**Warranty:**

Limited Lifetime



[Click here for product brochure](#)

[Click here for product price list](#)

**Description:**

Karma solidly satisfies a broad range of healthcare seating requirements from exam and patient rooms to waiting, meeting, administrative and cafeteria areas. Karma stacks with or without arms, is available with optional floor anchors, ganging brackets, or casters and comes in three sizes including bariatric. Also available in stool and easy access chair. Virtually all major components of Karma can be field replaced.

**Specifications:**

- Back: Upholstered in healthcare approved coated textile.
- Seat: Enhanced foam thickness, combined with webbed suspension system.
- Arms: Fixed polymer arms.
- Seat: Legs: Steel wall saver legs with floor saver glides.
- Extras: Includes sealed seams & underside for moisture barrier and bedbug prevention.
- Weight Capacity: 500 lbs.

**Dimensions:**

W	D	H	seat h	arm h
24.5"	21.9"	33.9"	18"	26.8"

**Finishes:**

Frame:



Silver Metallic      Polished Chrome      Black  
\*Upcharge

Arms:

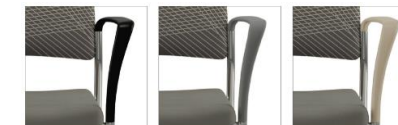

Black      Grey      Taupe

**Fabrics:**

[Click here to view Textiles](#)

# Krug: Manolo, bar stool



[Click here for product brochure](#)

[Click here for product price list](#)

### Description:

Manolo stools are available in both Bar and Counter height with a fully upholstered seat and back available in two back height options. The sled base metal frame is polished chrome and features non-marring polycarbonate glides. All major components of Manolo can be field replaced.

### Specifications:

- Seat and Back: Contoured plywood structure for supportive seating, covered in high density molded foam and upholstered in healthcare approved coated textile.
- Legs: Polished chrome structural steel sled base.
- Extras: Includes sealed seams & underside for moisture barrier and bedbug prevention.
- Weight Capacity: 300 lbs.

### Dimensions:

W	D	H	seat h
19"	22.5"	36"	31"

### Finishes:

Frame:



Polished Chrome

### Fabrics:

[Click here to view Textiles](#)

### Sustainability | Compliance:

BIFMA e3 & Air Emissions Certified



### Warranty:

Limited Lifetime

## Norix: Affinity, stacking chair



[Click here for product brochure](#)

**Description:** Blending a traditionally simple design with unmatched durability, Affinity is an excellent choice for any area. Available with or without arms, and optional upholstered or wood back. The versatile design lends itself well to lobbies, meeting spaces, and dining areas.

- Specifications:**
- Frame: Welded steel frames with durable metal seat pan for added strength and structural durability.
  - Cushions: Constructed using 1" foam wrapped in fabric with concealed staples
  - Arm Caps: Polyurethane
  - Back: Upholstered or wood back Glides: Injection molded glides
  - Tested to 500 lb. static load

- Dimensions:**
- Seat Height: 17.4
  - Seat Width: 18.5"
  - Arm Height: 26"
  - Overall Height: 32.1" - 32.5"
  - Overall Depth: 22.8"
  - Overall Width: 23.4"

**Finishes:**

Frame:



METALLIC SILVER

Arm Cap:



BLACK

**Sustainability | Compliance:**

GreenGuard Gold, BIFMA



**Warranty:**

10-years



**Fabrics:**

[Click here to view fabric guide](#)

[Click here to view Textiles](#)



## Spec: Snowball 2



[Click here for product brochure](#)

[Click here for product price list](#)

### Description:

Snowball 2 offers a unique fully upholstered back shape with enhanced contours for superior comfort. Perfect for your meeting room, conference room, waiting room, cafeteria, lounge, office. Options include CAL 133, sealed seams, moisture barrier, wall saving frame, connecting bars for a structured reconfigurable layout, tablet arm, wire basket and duraSpec seat.

### Specifications:

- Separate seat and back can be upholstered in 2 different fabrics
- Chairs are available with or without ganging
- Stacks 10 high with dolly, 6 on the floor
- Antimicrobial and antibacterial fabrics available
- Weight Capacity: 500 lbs.

### Dimensions:

w	d	h	seat h
18"	22"	33"	18"

### Finishes:

#### FRAME



Select from one of our 76 standard Spectone colors

#### FABRIC



Select fabrics from one of our textile partners

#### ARMS



Taupe

### Sustainability | Compliance:

BIFMA, Level, Can contribute to LEEDS® credits



### Warranty:

Lifetime structural warranty against defects in design, construction and materials. Finishes and cover materials 2-year warranty subject to normal wear and tear.

## Spec: Snowball 2, stool



[Click here for product brochure](#)

[Click here for product price list](#)

### Description:

Snowball 2 offers a unique fully upholstered back shape with enhanced contours for superior comfort. Perfect for your meeting room, conference room, waiting room, cafeteria, lounge, office. Options include CAL 133, sealed seams, moisture barrier, wall saving frame, connecting bars for a structured reconfigurable layout, tablet arm, wire basket and duraSpec seat.

### Specifications:

- Separate seat and back can be upholstered in 2 different fabrics
- Chairs are available with or without ganging
- Stacks 10 high with dolly, 6 on the floor
- Antimicrobial and antibacterial fabrics available
- Weight Capacity: 500 lbs.

### Dimensions:

w	d	h	seat h	seat w
20.13"	22"	43.5"	28"	18"

### Finishes:

#### FRAME



Select from one of our 76 standard Spectone colors

#### FABRIC



Select fabrics from one of our textile partners

#### ARMS



Taupe

### Sustainability | Compliance:

BIFMA, Level, Can contribute to LEEDS® credits



### Warranty:

Lifetime structural warranty against defects in design, construction and materials. Finishes and cover materials 2-year warranty subject to normal wear and tear.



A modern lounge area featuring two armchairs, one yellow and one grey, positioned in front of a large window. A small round coffee table with a white metal frame sits between them, holding a small orange bowl. The window offers a view of a modern building with a grid of windows. The room is decorated with a patterned wall on the left and potted plants on both sides. A semi-transparent blue banner is overlaid across the middle of the image, containing the text "Lounge | Soft Seating".

# Lounge | Soft Seating



# Knoll: Rockwell Unscripted, club chair



**Sustainability | Compliance:**

BIFMA Level®, Clean Air GOLD, Declare



**Warranty:**

12 Years, 3 years for upholstery



[Click here for product brochure](#)

[Click here for product price list](#)

**Description:**

The Unscripted Club Chair is a roomy home base for the hour or the day. The curved touchpoints, stitching details, and soft seat inspire hospitality at every turn. The solid wood legs are warm and modern; the wire base is casual and industrial; the swivel base (Petite only) is simple and sophisticated.

**Specifications:**

- + Available in standard and petite versions with wood legs or wire bases
- + Available with split upholstery as well as surged edge stitch on seat
- + Engineered hardwood and plywood frame, woven rubber webbing suspension, urethane foam with polyester fiber top and bottom layers

**Dimensions:**

	w	d	h	seat h
Full Size with Wire Base	33"	27"	29"	17.5"
Full Size with Wood Legs	33"	27"	29"	17.5"
Petite with Wire Base	26"	27"	29"	17.5"
Petite with Wood Legs	26"	27"	29"	17.5"
Petite with Swivel Base	26"	27"	29"	17.5"

**Finishes:**

Wood Legs:



Wire & Swivel Base:

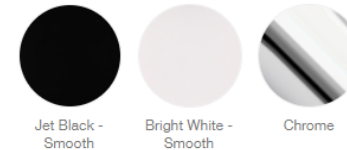

**Fabrics:**

[Click here for approved Textiles](#)

[Click here to view Textiles](#)

# Knoll: Rockwell Unscripted, settee



[Click here for product brochure](#)

[Click here for product price list](#)

**Description:**

Rockwell Unscripted lounge seating is upholstery as invitation. The Unscripted High Back Settee creates quiet space for one-on-one conversation or a place to sit back and survey the scene. The curved touchpoints, stitching details, and generous seat inspire hospitality at every turn.

**Specifications:**

- + Available with split upholstery as well as surged edge stitch on seat
- + Engineered hardwood and plywood frame, woven rubber webbing suspension, urethane foam with polyester fiber top and bottom layers
- + Removable solid wood legs

**Dimensions:**

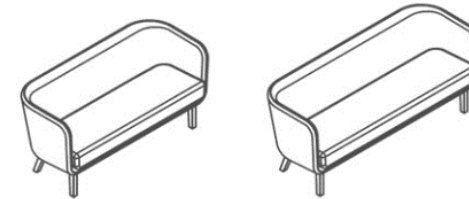

	w	d	h	seat h
Settee, Wood Legs	61"	27"	29"	17.5"
Sofa, Wood Legs	72"	27"	29"	17.5"

**Sustainability | Compliance:**

BIFMA Level®, Clean Air GOLD, Declare



**Warranty:**

12 Years, 3 years for upholstery

**Finishes:**

Wood Legs:



White Oak



Espresso-Stained Ash



Ebony-Stained Ash

**Fabrics:**

[Click here for approved Textiles](#)

[Click here to view Textiles](#)

# Knoll: Rockwell Unscripted, modular lounge

[Click here for product brochure](#)

[Click here for product price list](#)



### Description:

Rockwell Unscripted lounge seating is upholstery as invitation. The Unscripted High Back Settee creates quiet space for one-on-one conversation or a place to sit back and survey the scene. The curved touchpoints, stitching details, and generous seat inspire hospitality at every turn.

### Specifications:

- + Available with split upholstery as well as surged edge stitch on seat
- + Engineered hardwood and plywood frame, woven rubber webbing suspension, urethane foam with polyester fiber top and bottom layers
- + Removable solid wood legs
- + Ganging plates available for connecting pieces

### Dimensions:

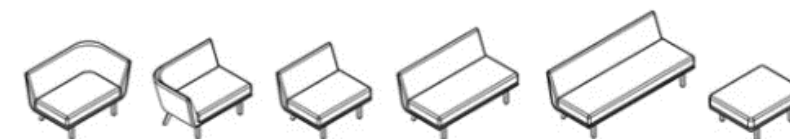

	w	d	h	seat h
Left Arm Chair	44"	29"	29"	16"
Right Arm Chair	44"	29"	29"	16"
Armless Settee	36"	29"	29"	16"
	54"	29"	29"	16"
Ottoman	36"	25"	16"	16"

### Sustainability | Compliance:

BIFMA Level®, Clean Air GOLD, Declare



### Warranty:

12 Years, 3 years for upholstery



### Finishes:

Wood Legs:



### Fabrics:

[Click here for approved Textiles](#)

[Click here to view Textiles](#)

# Knoll: Rockwell Unscripted, steps



[Click here for product brochure](#)

[Click here for product price list](#)

## Description:

Rockwell Unscripted Steps are building blocks for touchdown seating offering you the choice of where to perch and work. As simple cubic forms that plan together in a myriad of ways, Steps offer a wide range of planning options and are easily reconfigurable. A great solution to add extra seating to a meeting space or an easy way to create separation between two spaces.

## Specifications:

- + Versatile and easy cleanable solution for touchdown seating ganging device available for connecting pieces
- + Flexible design with both upholstered and non upholstered pieces
- + Option for integrated power

## Dimensions:

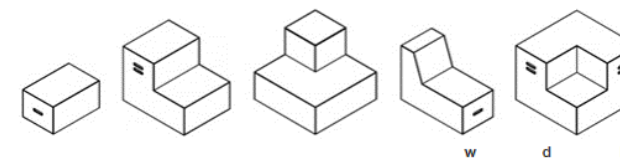

		w	d	h
<b>One Step</b>				
	Corner	20"	20"	16"
	Short*	30"	20"	16"
	Long*	60"	20"	16"
<b>Two Step</b>				
	Short*	30"	40"	31"
	Long*	60"	40"	31"
	Inside Corner	40"	40"	31"
	Outside Corner	40"	40"	31"
	Chaise*	20"	40"	31"

\*Available Covered

## Sustainability | Compliance:

BIFMA Level®, Clean Air GOLD



## Warranty:

5 Years, 1 years for upholstery



## Finishes:

### Plywood:

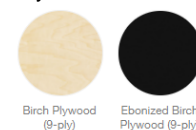

### Fabric:





# Krug: Solis, ganged seating, 3 seat



[Click here for product brochure](#)

[Click here for product price list](#)

### Description:

Solis guest and patient chairs feature highly durable materials and construction along with supportive comfort and a broad range of models, sizes and aesthetic options. Durable metal frame with clean out. Multi-density foam and spring seat construction provide exceptional seating comfort. Virtually all major components of Solis can be field replaced.

### Specifications:

- Back: Contoured and angled for supportive seating, upholstered in healthcare approved coated textile.
- Arms: Fixed metal arms with urethane arm caps.
- Seat: Spring seat construction with multi-density molded foam and clean-out.
- Legs: Steel wall saver legs.
- Extras: Includes sealed seams & underside for moisture barrier and bedbug prevention.
- Weight Capacity: 750 lbs.

### Dimensions:

W	D	H	seat h	arm h
69.5"	28"	34.5"	18.5"	26"

### Finishes:

#### Frame:

##### METAL COLOR OPTIONS



\*Silver Metallic standard – upcharge for other colours

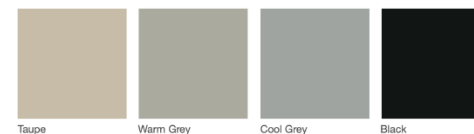

#### Arms:



### Sustainability | Compliance:

BIFMA e3 & Air Emissions Certified



### Warranty:

Limited Lifetime



### Fabrics:

[Click here to view Textiles](#)

# Krug: Solis, ganged seating, 4 seat



[Click here for product brochure](#)

[Click here for product price list](#)

### Description:

Solis guest and patient chairs feature highly durable materials and construction along with supportive comfort and a broad range of models, sizes and aesthetic options. Durable metal frame with clean out. Multi-density foam and spring seat construction provide exceptional seating comfort. Virtually all major components of Solis can be field replaced.

### Specifications:

- Back: Contoured and angled for supportive seating, upholstered in healthcare approved coated textile.
- Arms: Fixed metal arms with urethane arm caps.
- Seat: Spring seat construction with multi-density molded foam and clean-out.
- Legs: Steel wall saver legs.
- Extras: Includes sealed seams & underside for moisture barrier and bedbug prevention.
- Weight Capacity: 2000 lbs. [500 lbs. per seat]

### Dimensions:

W	D	H	seat h	arm h
94"	28"	34.5"	18.5"	26"

### Finishes:

#### Frame:

##### METAL COLOR OPTIONS



\*Silver Metallic standard – upcharge for other colours

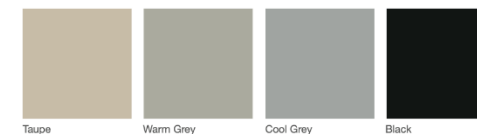

#### Arms:



### Sustainability | Compliance:

BIFMA e3 & Air Emissions Certified



### Warranty:

Limited Lifetime



### Fabrics:

[Click here to view Textiles](#)

## Krug: Jordan, lounge chair



[Click here for product brochure](#)

[Click here for product price list](#)

### Description:

Jordan lounge seating and sofas feature a canted seat angle with curvature in both seat and back. This along with a unique sinuous spring seat construction optimizes seating comfort, extends the life of the seat foam, promotes good circulation and assists in ingress and egress. Available with fully upholstered arms or full urethane arms. With an integrated clean out, urethane legs, recliners and sleeper chair versions plus a glider chair model make the Jordan line a favourite within healthcare settings. Virtually all major components of Jordan can be field replaced.

### Specifications:

- Back: Contoured and angled for supportive seating, upholstered in healthcare approved coated textile.
- Arms: Fully upholstered arms or optional full urethane arms.
- Seat: Sinuous spring seat construction with multi-density molded foam and clean-out.
- Legs: Urethane wall saver legs.
- Extras: Includes sealed seams & underside for moisture barrier and bedbug prevention.
- Weight Capacity: 350 lbs.

### Dimensions:

W	D	H	seat h	arm h
29"	30.5"	34.5"	17.25"	26"

### Finishes:

URETHANE COLOR OPTIONS



### Fabrics:

[Click here to view Textiles](#)

### Sustainability | Compliance:

BIFMA e3 & Air Emissions Certified



### Warranty:

Limited Lifetime

# Krug: Leyton, 2-seater sofa



[Click here for product brochure](#)

[Click here for product price list](#)

### Description:

Leyton lounge seating and sofas feature heavy duty construction for higher traffic and intensive use settings including bariatric applications. Leyton is also available in an armless version and has a complimentary Tate bench line. Features and options include integrated clean out, polished chrome structural steel legs and various arm cap options, tablets, push bars, casters and undermount power. Leyton chairs are designed to allow major components to be field replaced, providing a very cost-effective means to significantly extend the life of the product.

### Specifications:

- Back: Plywood substrate, angled for supportive seating, upholstered in healthcare approved coated textile
- Arms: Fully upholstered arms with solid surface arm caps
- Seat: No-Sag spring seat construction with multi-density molded foam and clean-out.
- Legs: Structural steel with polished chrome finish and non-marring glides.
- Extras: Includes sealed seams & underside for moisture barrier and bedbug prevention.
- Weight Capacity: 975 lbs.

### Dimensions:

W	D	H	seat h	arm h
52"	29.25"	31"	17.75"	26.25"

### Finishes:

Legs:



Polished Chrome

Arm Caps: (Standard)



Glacier White



Cameo White

Arm Caps: (Upcharge)



Bisque



Linen



Antarctica



Savannah



Dove



Deep Night Sky

### Sustainability | Compliance:

BIFMA e3 & Air Emissions Certified



### Warranty:

Limited Lifetime



### Fabrics:

[Click here to view Textiles](#)



## Krug: Zola, bank seating



### Sustainability | Compliance:

BIFMA e3 & Air Emissions Certified



### Warranty:

Limited Lifetime



[Click here for product brochure](#)

[Click here for product price list](#)

### Description:

Zola Modular and Privacy seating was designed for healthcare and other intensive use environments, including behavioural health and bariatric applications. Modular, metal to metal construction allows for complete cleaning and disinfecting of entire unit plus components are interchangeable, reconfigurable and replaceable. Both linear and curved shapes with three back height options provide an infinite number of configurations.

### Specifications:

- Back: Plywood substrate, curved for supportive seating, upholstered in healthcare approved coated textile.
- Arms: Fully upholstered arms with urethane arm caps.
- Seat: Webbed seat construction with multi-density molded foam and clean-out.
- Legs: Silver metallic legs with 1.25" levelling capability.
- Extras: Includes sealed seams & underside for moisture barrier and bedbug prevention.
- Weight Capacity: 1050 lbs. [option to upgrade to 1950 lbs.]

### Dimensions:

W	D	H	seat h	arm h
98"	27"	34"	18.5"	26.25"

### Finishes:

Legs:



Silver  
Metallic

Arm Caps:

URETHANE COLOR OPTIONS



Taupe



Grey

### Fabrics:

[Click here to view Textiles](#)

# Krug: Solis, access chair



[Click here for product brochure](#)

[Click here for product price list](#)

### Description:

Solis Easy Access chairs feature highly durable materials and construction along with supportive comfort. Available in two different widths and back heights. Durable metal frame with clean out and non-slip footrest to assist with ingress/egress and provide leg support while seated. Virtually all major components of Solis can be field replaced.

### Specifications:

- Back: Contoured and angled for supportive seating, upholstered in healthcare approved coated textile.
- Arms: Fixed metal arms with urethane arm caps.
- Seat: Spring seat construction with multi-density molded foam and clean-out.
- Legs: Steel wall saver legs with integrated non-slip footrest and adjustable glides on front legs.
- Extras: Includes sealed seams & underside for moisture barrier and bedbug prevention.
- Weight Capacity: 2000 lbs. [500 lbs. per seat]

### Dimensions:

W	D	H	seat h	arm h
25"	30.75"	40.5"	24.5"	32"

### Finishes:

#### Frame:

##### METAL COLOR OPTIONS



\*Silver Metallic standard – upcharge for other colours

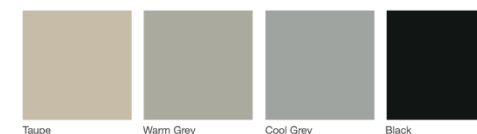

#### Arms:



### Sustainability | Compliance:

BIFMA e3 & Air Emissions Certified



### Warranty:

Limited Lifetime



### Fabrics:

[Click here to view Textiles](#)

## Krug: Jordan, recliner



Patient Transfer Arm

### Sustainability | Compliance:

BIFMA e3 & Air Emissions Certified



### Warranty:

Limited Lifetime



[Click here for product brochure](#)

[Click here for product price list](#)

### Description:

Jordan 3-Position Recliner has exceptional comfort with enhanced cushioning, providing lumbar and thoracic support for lengthy sitting and reclining. It's high-strength steel mechanism with Delrin wear pads has an incredible track record of continuous, problem-free use. Upholstered, full urethane or cushioned infusion arm styles available. Many options including electric recline, heat, central locking casters, patient transfer arm, Trendelenburg mechanism, sleep recliners, bariatric versions, foot trays, tablets, iv poles etc. Field replaceable components.

### Specifications:

- Back: Enhanced contoured cushioning in back and headrest for supportive seating, includes push bar and upholstered in healthcare approved coated textile.
- Arms: Full urethane arms & patient transfer arm.
- Seat: Dual-density molded foam for a softer seat.
- Legs: Locking casters.
- Extras: Includes sealed seams & underside for moisture barrier and bedbug prevention.
- Weight Capacity: 350 lbs. [Jordan Plus rated 500 lbs.]

### Dimensions:

W	D	H	seat h	arm h
29.5"	35-64"	45.5"	19.5"	28.25"

### Finishes:

URETHANE COLOR OPTIONS



### Fabrics:

[Click here to view Textiles](#)



## Norix: Boulder, beam 4 seats



 [Click here for product brochure](#)

### Description:

Norix Boulder™ Series Beam Seats have been in use in lobbies and waiting areas throughout the world...and are still going strong and looking good. Why? Because they're built to last, with powder coated tubular steel frames, welded steel plate seat supports, easy to clean molded polyethylene seats, heavy-duty glides and 9 tamper resistant screws to hold each seat in place.

### Specifications:

- Base Frame: Tubular steel, bent and welded to provide arm or armless in-line seating.
- Standard configurations for 3 to 5 people.
- Seats: One-piece seat and back. Smooth maintenance free surface allows for easy cleaning.
- Molded-in threaded steel inserts provide for tamper resistant attachment to base frame.

### Dimensions:

- Seat Height: 18"
- Seat Width: 17"
- Seat Depth: 16"
- Overall Height: 31.4"
- Overall Depth: 25"
- Arm Height: 24"

### Finishes:

#### Seat:

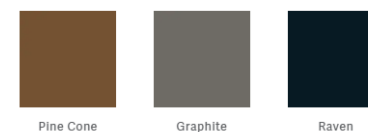

#### Frame:

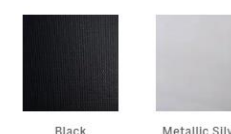

### Sustainability | Compliance:

GreenGuard Gold



### Warranty:

10-years

## Norix: Forma, single seat



### Sustainability | Compliance:

GreenGuard Gold



### Warranty:

10-years

 [Click here for product brochure](#)

### Description:

To provide customers and facilities with one source for all of their furniture needs, Norix® has expanded its offerings with Forma, a modular upholstered seating line that is designed with attractive features and engineered to be highly durable. The ten pieces in this designer-friendly line of products – including armchairs, cubes, benches and wedges.

### Specifications:

- Constructed of wood, 2.5" thick foam, enclosed wood panel with secure hardware and finished with upholstery.
- Optional plinth or steel base
- Optional ganging or Bolt-down.
- Optional Factory Ballasting (Plinth Base only) (50 lbs).
- Tested to 750 lb. static load

### Dimensions:

- Seat Height: 18.5"
- Overall Height: 32"
- Depth: 30"
- Width: 29.5"
- Arm Height: 26"

### Finishes:

Base:



METALLIC  
SILVER

### Fabrics:

 [Click here to view fabric guide](#)

 [Click here to view Textiles](#)

## Norix: Forma, double seat



### Sustainability | Compliance:

GreenGuard Gold



### Warranty:

10-years

 [Click here for product brochure](#)

### Description:

To provide customers and facilities with one source for all of their furniture needs, Norix® has expanded its offerings with Forma, a modular upholstered seating line that is designed with attractive features and engineered to be highly durable. The ten pieces in this designer-friendly line of products – including armchairs, cubes, benches and wedges.

### Specifications:

- Constructed of wood, 2.5" thick foam, enclosed wood panel with secure hardware and finished with upholstery.
- Optional plinth or steel base
- Optional ganging or Bolt-down.
- Optional Factory Ballasting (Plinth Base only) (50 lbs).
- Tested to 750 lb. static load

### Dimensions:

- Seat Height: 18.5"
- Overall Height: 32"
- Depth: 30"
- Width: 54"
- Arm Height: 26"

### Finishes:

Base:



METALLIC  
SILVER

### Fabrics:

 [Click here to view fabric guide](#)

 [Click here to view Textiles](#)

## Norix: Forma, bank seating



### Sustainability | Compliance:

GreenGuard Gold



### Warranty:

10-years

[Click here for product brochure](#)

### Description:

To provide customers and facilities with one source for all of their furniture needs, Norix® has expanded its offerings with Forma, a modular upholstered seating line that is designed with attractive features and engineered to be highly durable. The ten pieces in this designer-friendly line of products – including armchairs, cubes, benches and wedges.

### Specifications:

- Constructed of wood, 2.5" thick foam, enclosed wood panel with secure hardware and finished with upholstery.
- Optional plinth or steel base
- Optional ganging or Bolt-down.
- Optional Factory Ballasting (Plinth Base only) (50 lbs.)
- Tested to 750 lb. static load

### Dimensions:

- Seat Height: 18.5"
- Overall Height: 32"
- Depth: 30"
- Arm Height: 26"

### Finishes:

Base:



METALLIC  
SILVER

### Fabrics:

[Click here to view fabric guide](#)

[Click here to view Textiles](#)



## Norix: Terra, easy access chair



### Sustainability | Compliance:

GreenGuard Gold



### Warranty:

10-years



 [Click here for product brochure](#)

### Description:

Terra is tailored for one-stop shopping for highly durable and aesthetically pleasing integrated seating. Chairs are available in both a 22" and 30" wide variety and can stand alone, be set in row or be connected in tandem.

### Specifications:

- Frame: Welded steel frames
- Cushions: Constructed of a 2.0 lb density seat foam wrapped in fabric with concealed staples.
- Arm Caps: Hardwood (Maple, Teak, or Walnut color) or polyurethane in Raven
- Arm Options: Open, Half Arm, & Full Arm panels are MDF, foam & fabric
- Glides: Non-removable Nylon Glide.
- Tested to 750 lbs. static load

### Dimensions:

- Seat Height 19"
- Overall Height 34.8"
- Overall Depth 26" 22"
- Overall Width 26.5" 30"
- Overall Width 34.5"

### Finishes:

#### Frame:



BLACK



METALLIC  
SILVER



MAPLE



TEAK



WALNUT

#### Arm Caps - Wood:

#### Arm Caps - Polyurethane:



RAVEN

### Fabrics:

 [Click here to view fabric guide](#)

 [Click here to view Textiles](#)

# Spec: Tailor Modular

[Click here for product brochure](#)

[Click here for product price list](#)



Separate Seat and Back clean-out

**Description:**

Tailor makes a striking impression while keeping the requirements of hard-use applications in mind. Individual units work perfectly on their own or can be linked together to create a multitude of seamless configurations. Designed for simple re-configuration, units can be easily unlinked, and new components added for inspiring layouts in a wide range of settings. Tailor's adaptable design offers remarkable flexibility that is sure to suit any environment with complete confidence.

**Specifications:**

- One connecting plate per unit
- Ships assembled
- Separate seat and back, Glides
- Weight Capacity: 500 lbs.

**Dimensions:**

w	d	h
82"	29"	33"

**Finishes:**

**FRAME**



Select from one of our 76 standard Spectone colors

**LAMINATE**

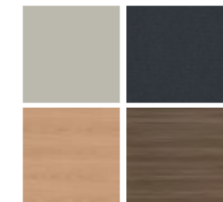

Select from 15 standard laminates or choose any standard Wilsonart, Nevamar, Formica, Arborite and Pionite matte finish laminates for no extra charge

**ARM CAPS**



Polyurethane



Wood\*

\*Wood arms are available in 9 standard stains or stain-to-match for no extra charge.

**FABRIC**



Select fabrics from one of our textile partners

**Sustainability | Compliance:**

BIFMA, Level, Can contribute to LEEDS® credits



**Warranty:**

Lifetime structural warranty against defects in design, construction and materials. Finishes and cover materials 2-year warranty subject to normal wear and tear.



## Spec: Snowball 2, 4 seats



[Click here for product brochure](#)

[Click here for product price list](#)

### Description:

Snowball 2 offers a unique fully upholstered back shape with enhanced contours for superior comfort. Perfect for your meeting room, conference room, waiting room, cafeteria, lounge, office. Options include CAL 133, sealed seams, moisture barrier, wall saving frame, connecting bars for a structured reconfigurable layout, tablet arm, wire basket and duraSpec seat.

### Specifications:

- Separate seat and back can be upholstered in 2 different fabrics
- Chairs are available with or without ganging
- Stacks 10 high with dolly, 6 on the floor
- Antimicrobial and antibacterial fabrics available
- Weight Capacity: 500 lbs.

### Dimensions:

w	d	h	seat h	seat w
94"	22"	33"	18"	23.5

### Finishes:

#### FRAME



Select from one of our 76 standard Spectone colors

#### FABRIC



Select fabrics from one of our textile partners

#### ARMS



Taupe

### Sustainability | Compliance:

BIFMA, Level, Can contribute to LEEDS® credits



### Warranty:

Lifetime structural warranty against defects in design, construction and materials. Finishes and cover materials 2-year warranty subject to normal wear and tear.

## Spec: Tailor, single seat



[Click here for product brochure](#)

[Click here for product price list](#)

### Description:

Tailor Freestanding makes a striking impression while keeping the requirements of hard-use applications in mind. Inspired by residential and hospitality designs, this lounge collection is well suited to corporate lobbies and healthcare facilities alike. The collection includes single and Bariatric models as well as two and three seat sofas. Group them together with freestanding tables, with or without power, to create purposeful environments tailored to your space.

### Specifications:

- Wall-saving frame
- Ships assembled
- Separate seat and back, Glides
- Weight Capacity: 500 lbs.

### Dimensions:

w	d	h	seat h	seat w
29.5"	29"	33"	18"	23"

### Finishes:

#### FRAME



Select from one of our 76 standard Spectone colors

#### ARMS



Black



Sterling Grey



Taupe

#### FABRIC



Select fabrics from one of our textile partners

### Sustainability | Compliance:

BIFMA, Level, Can contribute to LEEDS® credits



### Warranty:

Lifetime structural warranty against defects in design, construction and materials. Finishes and cover materials 2-year warranty subject to normal wear and tear.



## Spec: Tailor Modular, 2-seater



[Click here for product brochure](#)

[Click here for product price list](#)

### Description:

Tailor makes a striking impression while keeping the requirements of hard-use applications in mind. Individual units work perfectly on their own or can be linked together to create a multitude of seamless configurations. Designed for simple re-configuration, units can be easily unlinked, and new components added for inspiring layouts in a wide range of settings. Tailor's adaptable design offers remarkable flexibility that is sure to suit any environment with complete confidence.

### Specifications:

- One connecting plate per unit
- Ships assembled
- Separate seat and back, Glides
- Weight Capacity: 500 lbs./seat

### Dimensions:

w	d	h	seat h	seat w
52.5"	29"	33"	18"	23"

### Finishes:

#### FRAME



Select from one of our 76 standard Spectone colors

#### ARMS

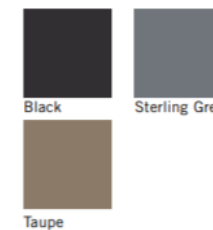

#### FABRIC



Select fabrics from one of our textile partners

### Sustainability | Compliance:

BIFMA, Level, Can contribute to LEEDS® credits



### Warranty:

Lifetime structural warranty against defects in design, construction and materials. Finishes and cover materials 2-year warranty subject to normal wear and tear.

## Spec: Tailor Modular, 4-seater



[Click here for product brochure](#)

[Click here for product price list](#)

### Description:

Tailor makes a striking impression while keeping the requirements of hard-use applications in mind. Individual units work perfectly on their own or can be linked together to create a multitude of seamless configurations. Designed for simple re-configuration, units can be easily unlinked, and new components added for inspiring layouts in a wide range of settings. Tailor's adaptable design offers remarkable flexibility that is sure to suit any environment with complete confidence.

### Specifications:

- One connecting plate per unit
- Ships assembled
- Separate seat and back, Glides
- Weight Capacity: 500 lbs./seat

### Dimensions:

w	d	h	seat h	seat w
98.5"	29"	33"	18"	23"

### Finishes:

#### FRAME



Select from one of our 76 standard Spectone colors

#### ARMS



Black



Sterling Grey



Taupe

#### FABRIC



Select fabrics from one of our textile partners

### Sustainability | Compliance:

BIFMA, Level, Can contribute to LEEDS® credits



### Warranty:

Lifetime structural warranty against defects in design, construction and materials. Finishes and cover materials 2-year warranty subject to normal wear and tear.



## Spec: Calvin, easy access hip single seater



[Click here for product brochure](#)

[Click here for product price list](#)

**Description:** Calvin's attractive silhouette is sure to get noticed in lobbies, lounges, and waiting rooms. And it comes in all kinds of designs to match your space, including one, two, and three seaters, bariatric, hip, freestanding, connected, and with or without tables

- Specifications:**
- Wall-saving, 14-gauge oval tube frame
  - Velcro removable back cover, replaceable seat
  - Ships assembled
  - Separate seat and back, Glides
  - Weight Capacity: 500 lbs./seat

**Dimensions:**

w	d	h	seat h	seat w
25"	26"	46"	24"	21"

**Finishes:**

**FRAME**



Select from one of our 76 standard Spectone colors

**FABRIC**



Select fabrics from one of our textile partners

**ARMS**

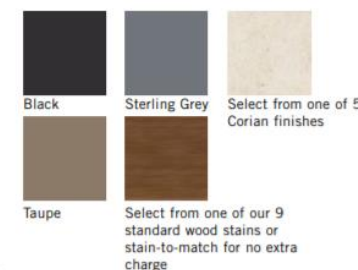

**Sustainability | Compliance:**

BIFMA, Level, Can contribute to LEEDS® credits



**Warranty:**

Lifetime structural warranty against defects in design, construction and materials. Finishes and cover materials 2-year warranty subject to normal wear and tear.



# Classics

A modern interior space featuring two armchairs, one yellow and one grey, positioned in front of a large window. A small round coffee table with a white top and metal legs sits between them, holding a small orange bowl. The window offers a view of a modern building with a grid of windows. The room has a patterned wall on the left and a potted plant on the right. A semi-transparent blue banner is overlaid across the middle of the image, containing the word "Classics" in white text.



## Knoll: Maya Lin, stones

[Click here for product brochure](#)

[Click here for product price list](#)



### Description:

Maya Lin's collection of Stones, introduced in 1998 in celebration of Knoll's 60th anniversary, reflects the famed architect's signature subtlety. "At the heart of this furniture collection for Knoll is my love for the land," says Lin. "It goes back to a childhood fascination we all have—that moment when you discover that the earth is round...and you walk around trying to see that curve." Stones are available in two sizes in a range of colors. Used as either stools or side tables, the stones are a colorful addition to the office, playroom or patio.

### Specifications:

- + Seat pad available in a range of KnollTextiles and Spinneybeck® leathers
- + Approved for outdoor use without seat pad
- + Stones can be specified with weight for added stability. There is no option for a sand kit if the Stones are ordered without weight
- + Security Kit available to anchor stones to the ground for permanent applications

### Dimensions:

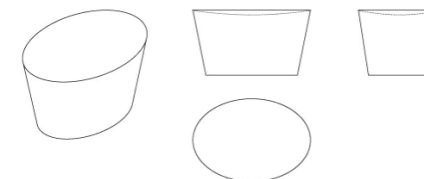

	w	d	h
84Y Maya Lin Child Stone	16"	12"	10"
83Y Maya Lin Adult Stone	27"	19"	15"

### Finishes:

Plastic:

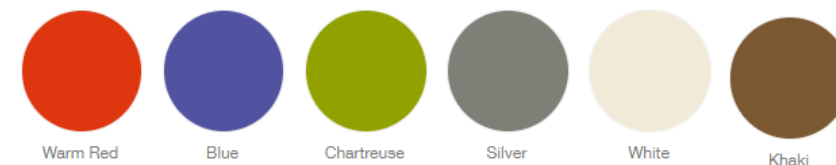

### Sustainability | Compliance:

Clean Air GOLD



### Warranty:

5 Years



# Knoll: Don Chadwick, spark series

[Click here for product brochure](#)

[Click here for product price list](#)



### Description:

The Spark series lounge and side chairs bring a spark of energy to every space through bright colors and unique personality. Offering a perfect balance between design and innovation, the chairs are comfortable for indoor, outdoor, dining, and lounge areas. The Spark chairs may be dressed up or down with the addition of an optional seat pad for indoor use, available in a wide array of fabric colors and textures.

### Specifications:

- + Seat pad available in a range of KnollTextiles and Spinneybeck® leathers
- + Approved for outdoor use without seat pad
- + Both side and lounge chairs stack six high on the floor and ten high on the Spark dolly

### Dimensions:

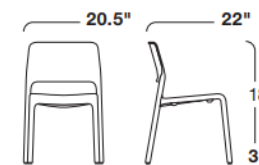

Side Chair  
Also available with seat pad

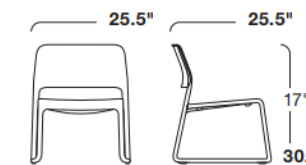

Lounge Chair  
Also available with seat pad

### Finishes:

Plastic:



Red      Blue      Citron      Light Grey      Dark Grey      Recycled Black

### Sustainability | Compliance:

Clean Air GOLD



### Warranty:

5 Years

# Knoll: Eero Saarinen, tables



## Sustainability | Compliance:

Clean Air GOLD



## Warranty:

5 Years



[Click here for product brochure](#)

[Click here for product price list](#)

### Description:

Eero Saarinen vowed to address the “ugly, confusing, unrestful world” he observed underneath chairs and tables -- the so-called "slum of legs." A five-year design investigation led him to the revolutionary Pedestal Collection, including what is perhaps the most recognized table of the modern era.

### Specifications:

- + Tabletop features beveled edge
- + Top attaches to base with threaded rod
- + Top available in round and oval shapes

### Dimensions:



Width: 16" – 96"

Depth: 15" – 54"

Height: 13" – 28.25"

### Finishes:

#### Marble [Coated or Satin]:



#### Wood:



#### Laminate:

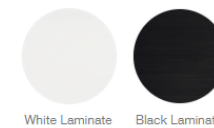

#### Base:

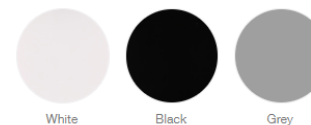

# Knoll: Harry Bertoia, molded shell chair

[Click here for product brochure](#)

[Click here for product price list](#)



### Description:

The Bertoia Molded Shell Side Chair is a reintroduction of a design originally debuted 1960. Merging the sublime grace of the wire-form side chair with a touch of color and natural flex, the reinvigorated classic is ready to add colorful accents to any room. Mix and match the chairs or keep a singular color palette, the Bertoia Molded Shell Side Chair offers an iconic design with a playful tone.

### Specifications:

- + Seat is glass fiber reinforced nylon
- + Base is constructed of welded steel rods with polished chrome finish or white or black powder coat
- + Plastic glides included on sled base to protect floors
- + Knoll logo stamped into the back of the base
- + Seat is glass fiber reinforced nylon for indoor shell (White, Orange Red, Yellow, and Blue)
- + Seat is polypropylene for outdoor shell (Medium Grey and Black)

### Dimensions:

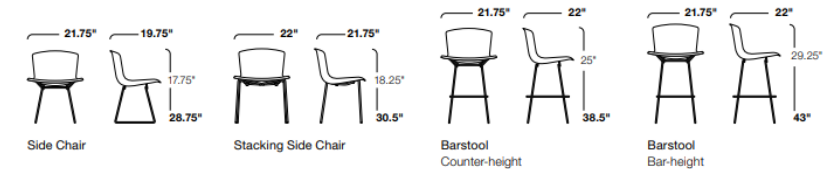

### Finishes:

#### Molded Shell Seat:

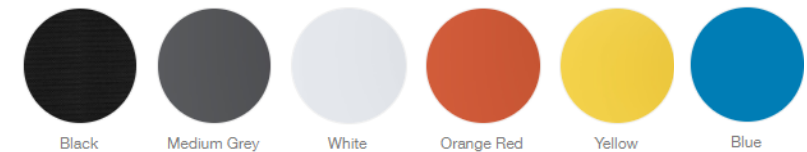

#### Frame:

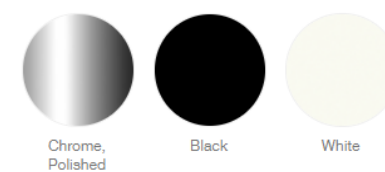

### Sustainability | Compliance:

Clean Air GOLD



### Warranty:

5 Years





# Knoll: Eero Saarinen, womb

[Click here for product brochure](#)

[Click here for product price list](#)



### Description:

Eero Saarinen designed the groundbreaking Womb Chair at Florence Knoll’s request for “a chair that was like a basket full of pillows... something I could really curl up in.” Eero Saarinen was eager to continue exploring the possibilities of a chair that achieved comfort through the shape of its shell, not the depth of its cushioning. The fiberglass design supports multiple sitting postures as well as a sense of enclosure. Designed in 1948, it remains one of the most iconic symbols of mid-century modern design.

### Specifications:

- + Available in 3 sizes, including a child’s size
- + Ottoman and settee are also available
- + Seat shell is foam-covered molded fiberglass
- + Steel legs are seamless tubular steel

### Dimensions:

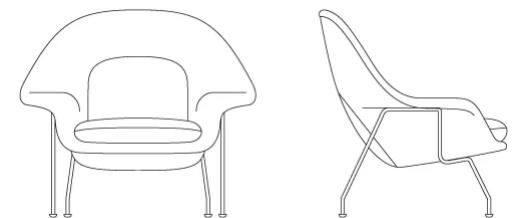

	w	d	h	seat h	arm h
70L Womb Chair	40"	34"	35.5"	16"	20.5"

### Sustainability | Compliance:

Clean Air GOLD



### Warranty:

5 Years

### Finishes:

Legs:

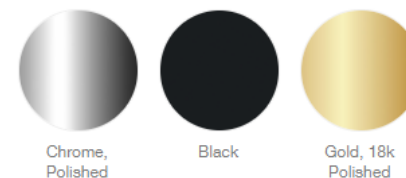

[Click here to view Textiles](#)

# Knoll: Warren Platner, tables



[Click here for product brochure](#)

[Click here for product price list](#)

### Description:

In 1966, the Platner Collection captured the “decorative, gentle, graceful” shapes that were beginning to infiltrate the modern vocabulary. The iconic pieces are created by welding hundreds of curved steel rods to circular frames, simultaneously serving as structure and ornament.

### Specifications:

- + Round top sits on base of vertical steel wire rods welded to circular horizontal and edge-framing rods
- + Clear plastic extrusion ring on bottom of the base for a smooth bottom surface

### Dimensions:

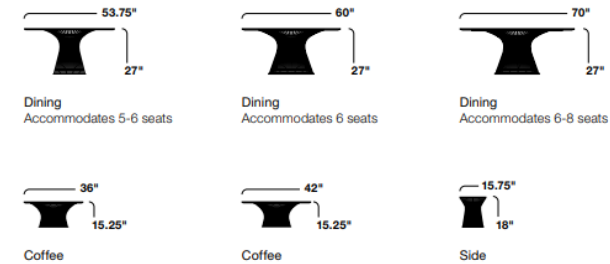

### Finishes:

#### Marble [Coated or Satin]:

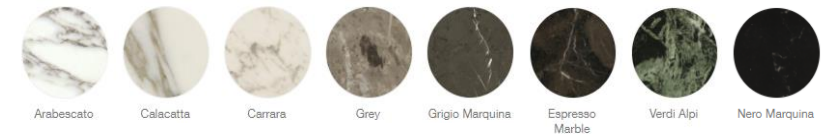

#### Wood:



#### Glass:



#### Base:

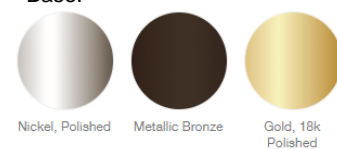

### Sustainability | Compliance:

Clean Air GOLD



### Warranty:

5 Years



## Knoll: Jehs+Laub, lounge chair



### Sustainability | Compliance:

Clean Air GOLD



### Warranty:

5 Years



[Click here for product brochure](#)

[Click here for product price list](#)

### Description:

The Jehs+Laub Collection for KnollStudio, inspired by the structure and geometry of earlier Knoll designs by Mies van der Rohe, Florence Knoll and Harry Bertoina, is the latest in a long and distinguished line of Knoll lounge furniture. The sweeping form of the Lounge Chair features a streamlined profile and a composed, inviting interior inspired by traditional quilting.

### Specifications:

- + Polyurethane foam with polyester-fiber backing used for upholstery
- + Hidden seam tufting eliminates the need for traditional pulls or buttons
- + Shell is molded and reinforced urethane
- + Back of shell can be articulated, allowing the top section to be flexible
- + Available with wire base in polished chrome or textured black paint or pedestal base in polished aluminum or textured black paint
- + Pedestal base has optional return to center mechanism which allows for 360-degree swivel movement and returns to a center position when not engaged

### Dimensions:

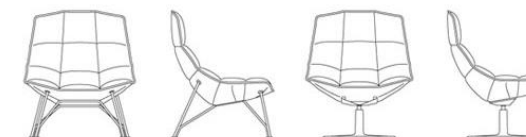

	w	d	h	seat h
JL1-W Jehs+Laub with Wire Base	33.25"	30.5"	38"	14.5"
JL1-P Jehs+Laub with Pedestal Base	33.25"	30.5"	38.5"	15"

### Finishes:

#### Pedestal Base:



Aluminum, Polished



Textured Black Powder Coat

#### Wire Base:



Chrome, Polished



Textured Black Powder Coat

[Click here to view Textiles](#)

# Knoll: Ludwig Mies van der Rohe, barcelona

[Click here for product brochure](#)

[Click here for product price list](#)

### Description:

One of the most recognized objects of the last century, and an icon of the modern movement, the Barcelona Chair's simple elegance and graceful profile epitomize Mies van der Rohe's most famous maxim—"less is more." From the hand-buffed stainless or chrome frame to the individual leather squares carefully welted together, each Barcelona piece is a tribute to the marriage of modern design and exceptional craftsmanship.

### Specifications:

- + Cushions are available in standard or relaxed styles
- + Upholstered with 40 individual panels. Individual panels are cut, hand-welted, and hand-tufted with leather buttons produced from a single cowhide
- + Upholstery straps are cowhide belting leather. Sides are dyed to match specified upholstery color. 17 straps are used for cushion support
- + Polished chrome, hand-ground and hand-buffed to a mirror finish. Upholstery straps attached with aluminum rivets
- + Premium grade 304 bar stock stainless steel. Frame is shaped, welded and hand-buffed to a mirror finish. Upholstery straps attached with solid stainless steel screws

### Dimensions:



	w	d	h	seat h
250L Barcelona Chair	29.5"	30"	30.25"	17"
251Y Barcelona Stool	25"	23.25"	14.75"	14.75"

### Finishes:

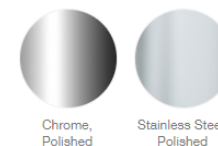

Chrome, Polished

Stainless Steel, Polished

[Click here to view Approved Textiles](#)

[Click here to view Textiles](#)



### Sustainability | Compliance:

Clean Air GOLD



### Warranty:

5 Years





# Knoll: Jens Risom, risom collection

[Click here for product brochure](#)

[Click here for product price list](#)



## Description:

The first pieces conceived for and manufactured by Knoll, Jens Risom's furniture was originally constructed of simple maple frames and discarded parachute webbing due to wartime material restrictions. Described as good, honest furniture design, the collection helped establish Knoll as an early provider of modern design in America.

## Specifications:

- + Webbing Options: Cotton, Sunbrella® or Cotton/Nylon
- + Frame: mortise and tenon construction, catalyzed lacquer finish
- + Back available with wood slat or webbed

## Dimensions:

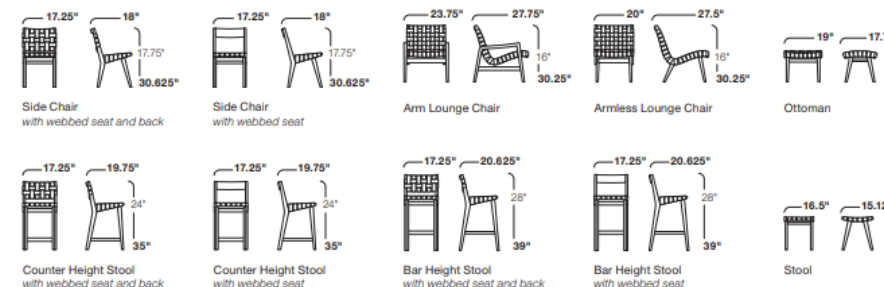

## Finishes:

### Frame:

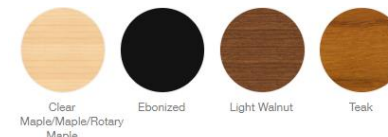

### Sunbrella:



### Cotton:



### Cotton/Nylon:



## Sustainability | Compliance:

Clean Air GOLD



## Warranty:

5 Years







Storage

## Knoll: Calibre, 3 high lateral file



 [Click here for product information](#)

 [Click here for product price list](#)

### Description:

Calibre filing and storage maximizes your organizational options without compromising valuable workspace. 1.5" drawer-height increments mean less wasted vertical space and greater utility per case. Calibre integrates seamlessly with other Knoll products to bring durable, intelligent storage to any workplace. From documents and binders to coats and office supplies, Calibre provides a place for everything.

### Specifications:

- + Full length integrated pull
- + Inner frame, case top & base, and drawer body: 20-gauge steel
- + Wrapper: 22-gauge steel
- + Ball bearing suspension
- + Interlocking drawers to prevent toppling
- + Levellers: zinc plated steel threaded rods with nylon pads for 3/4" overall adjustment
- + Paint Finish: Electrostatic applied powder-coat epoxy

### Dimensions:

36W" 18D" x 39H"

### Finishes:

Paint:



### Sustainability | Compliance:

BIFMA Level®, Clean Air GOLD, LEED



### Warranty:

12 Years



## Knoll: Calibre, 5 high lateral file



 [Click here for product information](#)

 [Click here for product price list](#)

### Description:

Calibre filing and storage maximizes your organizational options without compromising valuable workspace. 1.5” drawer-height increments mean less wasted vertical space and greater utility per case. Calibre integrates seamlessly with other Knoll products to bring durable, intelligent storage to any workplace. From documents and binders to coats and office supplies, Calibre provides a place for everything.

### Specifications:

- + Full length integrated pull
- + Inner frame, case top & base, and drawer body: 20-gauge steel
- + Wrapper: 22-gauge steel
- + Ball bearing suspension
- + Interlocking drawers to prevent toppling
- + Levellers: zinc plated steel threaded rods with nylon pads for 3/4” overall adjustment
- + Paint Finish: Electrostatic applied powder-coat epoxy

### Dimensions:

36W” 18D” x 63H”

### Finishes:

Paint:



### Sustainability | Compliance:

BIFMA Level®, Clean Air GOLD, LEED



### Warranty:

12 Years



## Knoll: Calibre, 3 high open cabinet



 [Click here for product information](#)

 [Click here for product price list](#)

### Description:

Calibre filing and storage maximizes your organizational options without compromising valuable workspace. 1.5” drawer-height increments mean less wasted vertical space and greater utility per case. Calibre integrates seamlessly with other Knoll products to bring durable, intelligent storage to any workplace. From documents and binders to coats and office supplies, Calibre provides a place for everything.

### Specifications:

- + Inner frame, case top & base, and drawer body: 20-gauge steel
- + Wrapper: 22-gauge steel
- + Ball bearing suspension
- + Interlocking drawers to prevent toppling
- + Levellers: zinc plated steel threaded rods with nylon pads for ¾” overall adjustment
- + Paint Finish: Electrostatic applied powder-coat epoxy

### Dimensions:

36W” 18D” x 43.5H”

### Finishes:

Paint:



### Sustainability | Compliance:

BIFMA Level®, Clean Air GOLD, LEED



### Warranty:

12 Years



## Knoll: Calibre, 5 high open cabinet



 [Click here for product information](#)

 [Click here for product price list](#)

### Description:

Calibre filing and storage maximizes your organizational options without compromising valuable workspace. 1.5” drawer-height increments mean less wasted vertical space and greater utility per case. Calibre integrates seamlessly with other Knoll products to bring durable, intelligent storage to any workplace. From documents and binders to coats and office supplies, Calibre provides a place for everything.

### Specifications:

- + Inner frame, case top & base, and drawer body: 20-gauge steel
- + Wrapper: 22-gauge steel
- + Ball bearing suspension
- + Interlocking drawers to prevent toppling
- + Levellers: zinc plated steel threaded rods with nylon pads for ¾” overall adjustment
- + Paint Finish: Electrostatic applied powder-coat epoxy

### Dimensions:

36W” 18D” x 64.5H”

### Finishes:

Paint:



### Sustainability | Compliance:

BIFMA Level®, Clean Air GOLD, LEED



### Warranty:

12 Years



## Knoll: Calibre, 5 high closed cabinet



 [Click here for product information](#)

 [Click here for product price list](#)

### Description:

Calibre filing and storage maximizes your organizational options without compromising valuable workspace. 1.5” drawer-height increments mean less wasted vertical space and greater utility per case. Calibre integrates seamlessly with other Knoll products to bring durable, intelligent storage to any workplace. From documents and binders to coats and office supplies, Calibre provides a place for everything.

### Specifications:

- + Full length integrated pull
- + Inner frame, case top & base, and drawer body: 20-gauge steel
- + Wrapper: 22-gauge steel
- + Ball bearing suspension
- + Interlocking drawers to prevent toppling
- + Levellers: zinc plated steel threaded rods with nylon pads for 3/4” overall adjustment
- + Paint Finish: Electrostatic applied powder-coat epoxy

### Dimensions:

36W” 18D” x 64.5H”

### Finishes:

Paint:



### Sustainability | Compliance:

BIFMA Level®, Clean Air GOLD, LEED





### Warranty:

12 Years

## Knoll: Calibre, 5 high lateral file/closed cabinet



 [Click here for product information](#)

 [Click here for product price list](#)

### Description:

Calibre filing and storage maximizes your organizational options without compromising valuable workspace. 1.5” drawer-height increments mean less wasted vertical space and greater utility per case. Calibre integrates seamlessly with other Knoll products to bring durable, intelligent storage to any workplace. From documents and binders to coats and office supplies, Calibre provides a place for everything.

### Specifications:

- + Full length integrated pull
- + Inner frame, case top & base, and drawer body: 20-gauge steel
- + Wrapper: 22-gauge steel
- + Ball bearing suspension
- + Interlocking drawers to prevent toppling
- + Levellers: zinc plated steel threaded rods with nylon pads for ¾” overall adjustment
- + Paint Finish: Electrostatic applied powder-coat epoxy

### Dimensions:

36W” 18D” x 64.5H”

### Finishes:

Paint:



### Sustainability | Compliance:

BIFMA Level®, Clean Air GOLD, LEED



### Warranty:

12 Years



## Knoll: Series 2, tower



### Sustainability | Compliance:

BIFMA Level®, Clean Air GOLD, LEED



### Warranty:

12 Years



 [Click here for product information](#)

 [Click here for product price list](#)

### Description:

Series 2 collection, featuring numerous finishing and detailing options, provides attractive supplemental storage for any Knoll office system. Available with steel, laminate and veneer fronts, or with fronts to specifically coordinate with Dividends Horizon, Template and Morrison systems. Series 2 can be styled to fit any office aesthetic.

### Specifications:

- + Full length integrated pull
- + Inner frame, case top & base, and drawer body: 20-gauge steel
- + Wrapper: 22-gauge steel
- + Ball bearing suspension
- + Interlocking drawers to prevent toppling
- + Levellers: zinc plated steel threaded rods with nylon pads for 3/4" overall adjustment
- + Paint Finish: Electrostatic applied powder-coat epoxy

### Dimensions:

24W" 24D" x 64H"

### Finishes:

#### Paint:



#### Laminate:

 [Click here to view laminates](#)

## Knoll: Series 2, mobile pedestal



### Sustainability | Compliance:

BIFMA Level®, Clean Air GOLD, LEED



12 Years

### Warranty:



[Click here for product information](#)

[Click here for product price list](#)

### Description:

Series 2 collection, featuring numerous finishing and detailing options, provides attractive supplemental storage for any Knoll office system. Available with steel, laminate and veneer fronts, or with fronts to specifically coordinate with Dividends Horizon, Template and Morrison systems. Series 2 can be styled to fit any office aesthetic.

### Specifications:

- + Full length integrated pull
- + Inner frame, case top & base, and drawer body: 20-gauge steel
- + Wrapper: 22-gauge steel
- + Ball bearing suspension
- + Full extensions slides on drawers
- + Paint Finish: Electrostatic applied powder-coat epoxy

### Dimensions:

15W" 22.75D" x 21.5H"

### Finishes:

#### Paint:



#### Laminate:

[Click here to view laminates](#)

# Knoll: Anchor, lockers



[Click here for product information](#)

[Click here for product price list](#)

**Description:**

With its universal aesthetic, broad scope and power and technology capabilities, Anchor answers storage needs across a variety of spaces. Anchor lockers are an efficient “home base” in the workplace, offering storage for personal items in an economical footprint.

**Specifications:**

- + Lockers offer privacy and create space delineation
- + Smart-locking feature gives users a sense of security
- + Wood construction, 100% recycled content particleboard

**Dimensions:**

	w	d	h
A. Locker Banks	12, 24, 36, 48, 60, 72, 84, 96"	20, 24, 40, 48"	42, 50, 57, 64, 71"
B. Workstation Lockers	12"	20, 24, 30"	42, 50, 57, 64"
C. Raised Workstation Lockers	12"	20, 24, 30"	42, 50, 57, 64"

**Finishes:**

Laminate:



Paint:



**Sustainability | Compliance:**

BIFMA Level®, Clean Air GOLD, LEED, FSC



**Warranty:**

10 Years



# Freestanding Furniture





## Knoll: Ref Profiles, Typical 1



## Knoll: Reff Profiles, Typical 1

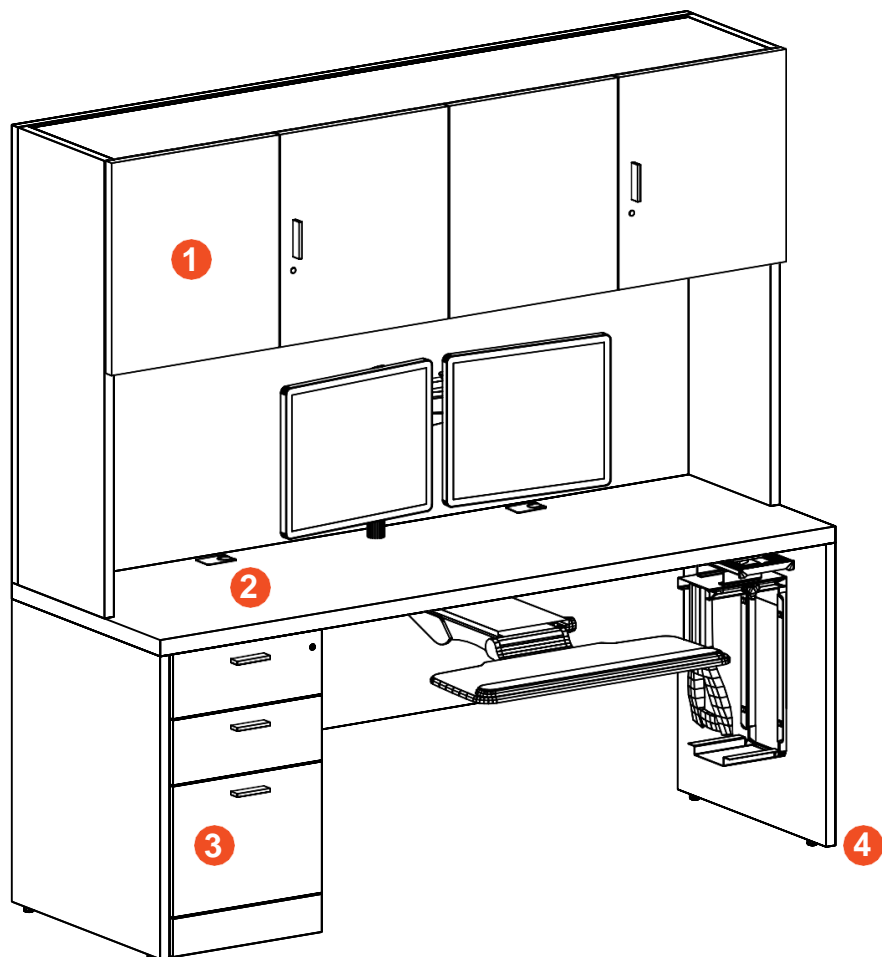

**1** Hutch

Height of single high surround; with 1 1/2" thick top is 42 5/8" high and with 1 1/4" thick top is 42 31/32" high. Comes with tackboard. Accepts wood grain laminate, where laminate is currently an option. For any vertical surface greater than 60" wide, the grain direction is horizontal.

**2** Worksurfaces | Gables

Tops are 1 1/2" or 1 1/4" thick. Flush and cantilever top assemblies have 1 1/16" or 2 1/16" thick end panels, and 15/16" thick back panels. Recessed top assemblies have 1 1/16" or 2 1/16" thick end panels and a 15/16" thick back panel.

**3** Pedestal

Pedestals are supplied with metal channels on the top to attach the pedestal to the underside of a worksurface. Drawer boxes can be specified in either metal or wood. Box and file drawers have full extension steel, ball bearing slides and are designed to meet BIFMA loading standards.

**4** Levelers

1 1/2" level, allowing 1 1/4" adjustability

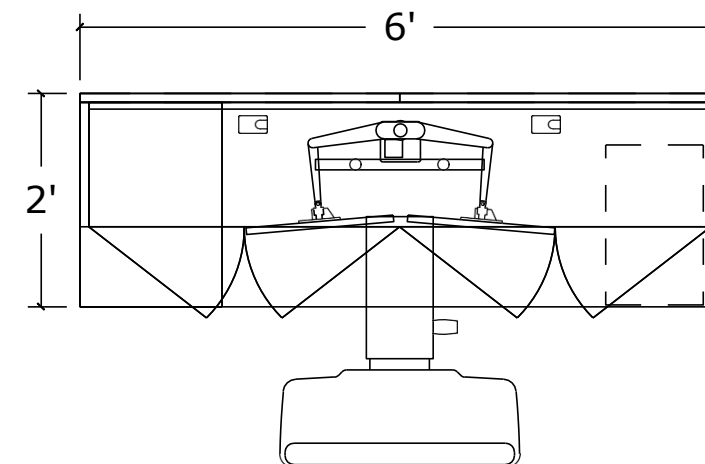

## Knoll: Reff Profiles, Typical 1



### Sustainability | Compliance:

BIFMA Level®, Clean Air GOLD, LEED, FSC



### Warranty:

10 Years



[Click here for product brochure](#)

[Click here for price list Volume 1](#)

[Click here for price list Volume 2](#)

### Description:

Reff Profiles offers broadened aesthetic options and increased design flexibility, with components ranging from grounded work walls to freestanding desks and tables to support different applications, aesthetics and budgets. From the corner office in floor-to-ceiling walnut, to the fast-paced team space in glass and aluminum, Reff Profiles delivers.

### Specifications:

- + Desk with half modesty
- + BBF pedestal
- + Hutch with tackboard and light
- + Double monitor arm, keyboard tray and CPU holder

### Dimensions:

24" x 72"

### Finishes:

Laminate:



### Fabrics:

[Click here for approved Textiles](#)

[Click here to view Textiles](#)

## Knoll: Reff Profiles, Typical 2





## Knoll: Reff Profiles, Typical 2

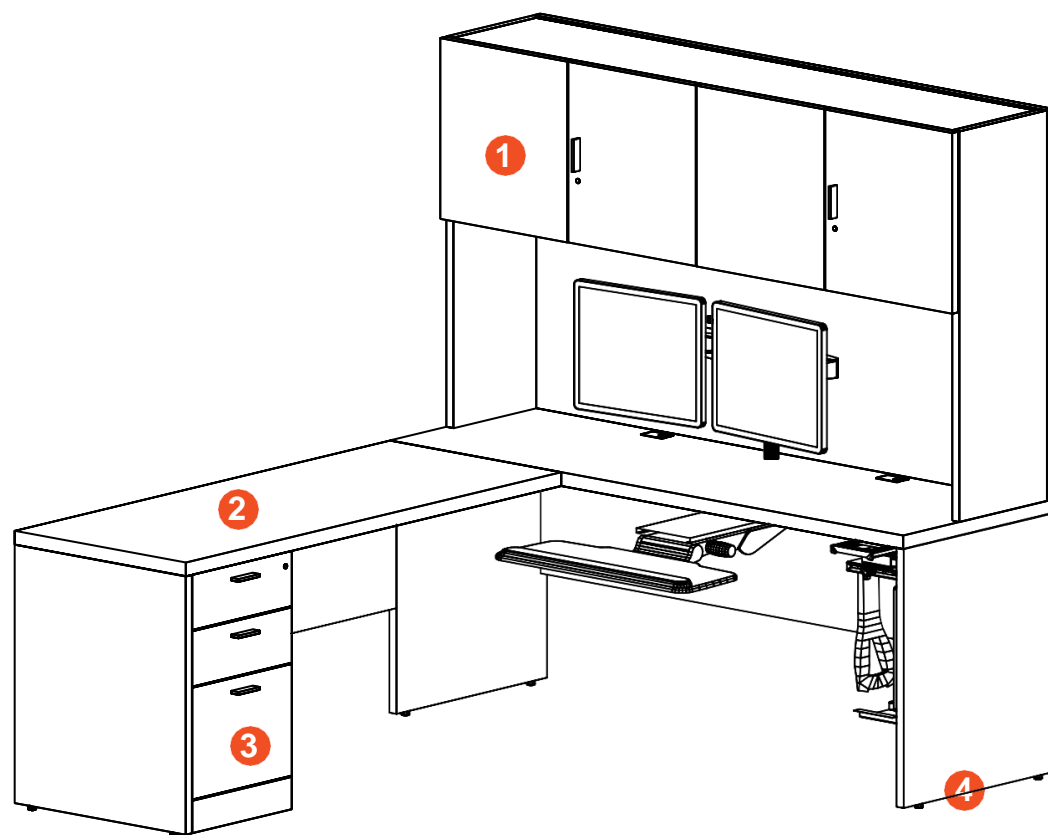

**1** Hutch

Height of single high surround; with 1 1/2" thick top is 42 5/8" high and with 1 1/4" thick top is 42 31/32" high. Comes with tackboard. Accepts wood grain laminate, where laminate is currently an option. For any vertical surface greater than 60" wide, the grain direction is horizontal.

**2** Worksurfaces | Gables

Tops are 1 1/2" or 1 1/4" thick. Flush and cantilever top assemblies have 1 1/16" or 2 1/16" thick end panels, and 15/16" thick back panels. Recessed top assemblies have 1 1/16" or 2 1/16" thick end panels and a 15/16" thick back panel.

**3** Pedestal

Pedestals are supplied with metal channels on the top to attach the pedestal to the underside of a worksurface. Drawer boxes can be specified in either metal or wood. Box and file drawers have full extension steel, ball bearing slides and are designed to meet BIFMA loading standards.

**4** Levelers

1 1/2" levelers, allowing 1 1/4" adjustability.

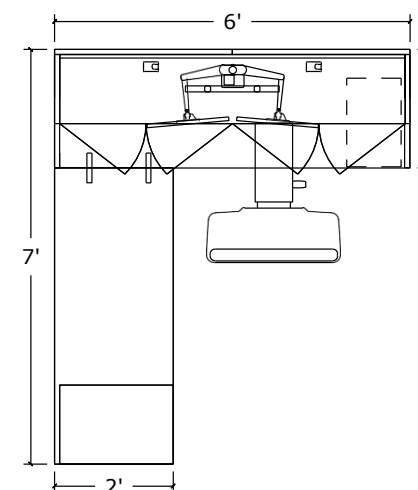

## Knoll: Reff Profiles, Typical 2



**Sustainability | Compliance:**

BIFMA Level®, Clean Air GOLD, LEED, FSC



**Warranty:**

10 Years



[Click here for product brochure](#)

[Click here for price list Volume 1](#)

[Click here for price list Volume 2](#)

**Description:**

Reff Profiles offers broadened aesthetic options and increased design flexibility, with components ranging from grounded work walls to freestanding desks and tables to support different applications, aesthetics and budgets. From the corner office in floor-to-ceiling walnut, to the fast-paced team space in glass and aluminum, Reff Profiles delivers.

**Specifications:**

- + Desk and return with half modesty
- + BBF pedestal
- + Hutch with tackboard and light
- + Double monitor arm, keyboard tray and CPU holder

**Dimensions:**

Main Surface: 24" x 72"  
Return: 24" x 60"

**Finishes:**

Laminate:



**Fabrics:**

[Click here for approved Textiles](#)

[Click here to view Textiles](#)



# Systems Furniture

A modern office workstation setup. The desk is white with a dual-monitor system. A white storage cabinet on wheels is positioned under the desk. A perforated blue privacy screen is attached to the desk. The desk is on a wooden floor. The background shows a grey wall with vertical panels.

**Knoll: Dividends Horizon, Typical 3**





## Knoll: Dividends Horizon, Typical 3

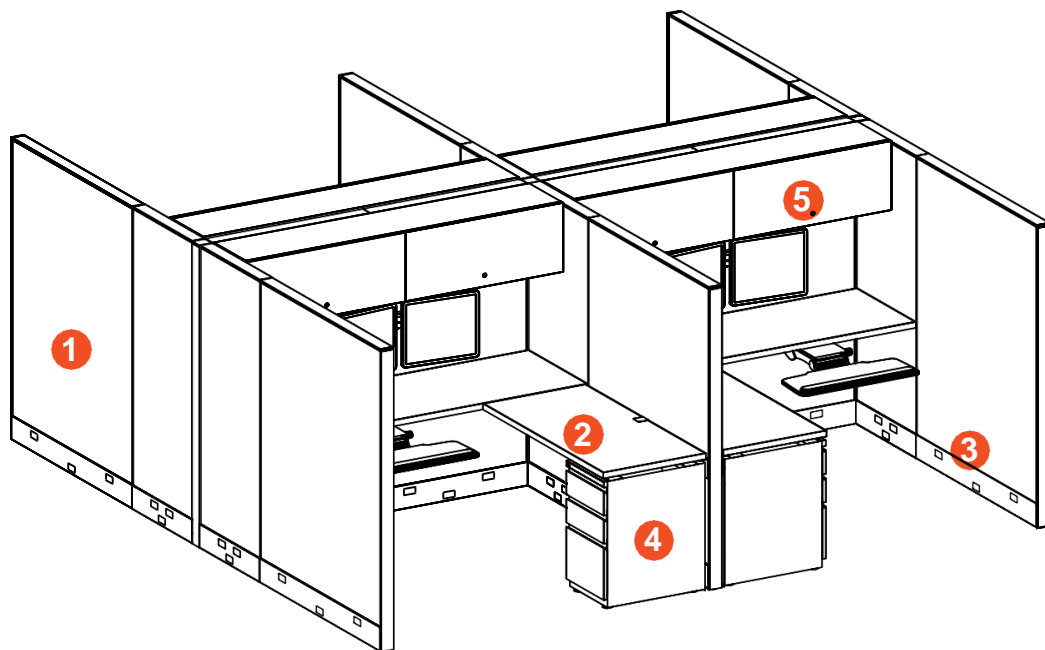

### 1 Panels

Panel frames are robotically welded and consist of vertical channels, horizontal rails and panel feet with leveling glides. Vertical channels: 16-gauge roll-formed steel with 5/8" integral slotted standard with adjustments in 1-1/2" increments. Horizontal rails: 15-gauge roll-formed steel. Panel feet: extruded aluminum.

Leveling glides: Steel threads with 2-1/4" height adjustment and 1-1/2" diameter nylon foot.

### 2 Worksurfaces

- + Surface material: .028 laminate on top surface with a paper backer on under side
- + Edge material: 2mm ABS on straight and curved surfaces
- + Core material: 45 lb. density particle board
- + Thickness: 1 1/4"

### 3 Electrical

Base Raceway Provides duplex receptacle and data port access at base H x 2 7/8"D. Construction: Paint-colored 22-gauge roll-form steel cover. height.

Feature two roll formed steel raceway covers, which are available with or without electrical/data knockouts.

### 4 Pedestal

Exterior dimension: 5"H x 2 15/16"D. Interior dimension: 5"

- + Outer wrapper: 20-gauge steel
- + Drawer front: 20-gauge steel (double wide front: 18-gauge)
- + Pedestal back: 20-gauge
- + 7/8 extension ball bearing (full extension available as an option)
- + Full extension ball bearing
- + Leveling glides: 3/8 diameter steel stem with 1 1/2 of height adjustment (double wide ped: 5/16 diameter steel stem with a 1 9/16 of height adjustment)

### 5 Overheads

- + Horizontal top and shelf: 18-gauge painted roll-formed steel
- + Overhead door: - Steel: 20-gauge painted steel - Laminate: 3/4" particle board with laminate on the outside and a paper backer on the inside. 1mm edge band. - Veneer: 3/4" thick particle board with 0.6mm thick veneer on the top and edge.

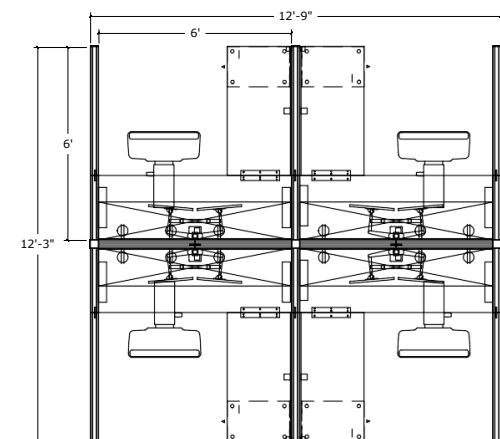

# Knoll: Dividends Horizon, Typical 3



[Click here for product brochure](#)

[Click here for product price list](#)

### Description:

Dividends Horizon® has supported the evolving workplace, pairing proven performance with current planning and technology needs. Dividends Horizon® provides spatial impact with a clean aesthetic for both the open plan and enclosed spaces. Easily reconfigurable, workstation elements and freestanding furniture can also be reimagined to address future change.

### Specifications:

- + 64”H panels
- + Laminate worksurfaces
- + BBF pedestal
- + Overhead storage with light
- + Double monitor arm and keyboard tray

### Finishes:

Laminate:



### Sustainability | Compliance:

BIFMA Level®, Clean Air GOLD, LEED, FSC, Declare



Declare.

### Warranty:

10 Years



### Fabrics:

[Click here for approved Textiles](#)

[Click here to view Textiles](#)



# Benching



**Knoll:** Dividends Horizon, Anchor & K.stand, Typical 4





## Knoll: Dividends Horizon, Anchor & K.Stand, Typical 4

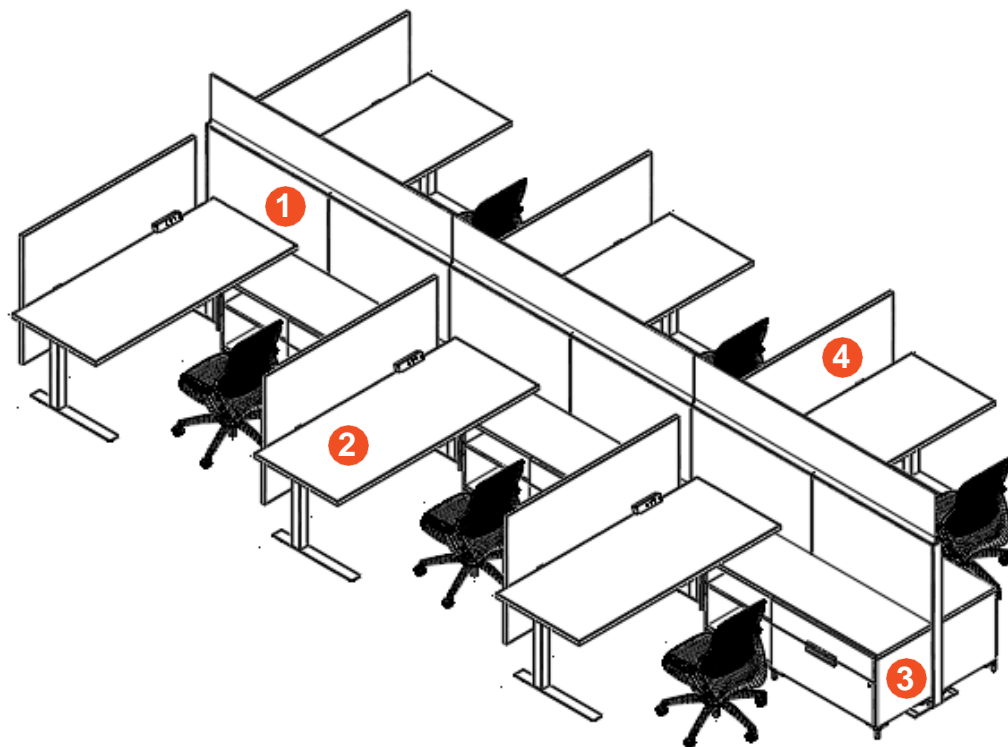

### 1 Panels

Panel frames are robotically welded and consist of vertical channels, horizontal rails and panel feet with leveling glides. Vertical channels: 16-gauge roll-formed steel with 5/8" integral slotted standard with adjustments in 1-1/2" increments. Horizontal rails: 15-gauge roll-formed steel. Panel feet: extruded aluminum. Leveling glides: Steel threads with 2-1/4" height adjustment and 1-1/2" diameter nylon foot.

- 2** Height Adjustable Desks
  - + Surface: .028 laminate on top surface with a paper backer on under side. Edge: 2mm ABS on straight and curved surfaces. Core: 45 lb. density particle board. Thickness: 11/4"
  - + Base: 265 lb. lifting capacity. Meets UL 962 for table assembly. Dual and Triple motors. Dual rated electrical for global use. Standard collision detection
- 3** Credenzas
  - + Wood construction
  - + 100% recycled content particleboard
  - + Steel and aluminum components recyclable
  - + PVC-free
  - + Adhesives and finishes are virtually VOC-free
- 4** Screens
 

Frameless screens are 3/4" MDF construction, with threaded inserts at bracket locations. Fabric screens have a 1/2" MDF core, with 3/8" thick tackable PET material inserts on each side wrapped in fabric, and aluminum perimeter frame with seamless corners. Fabric screens have threaded metal inserts at bracket locations.

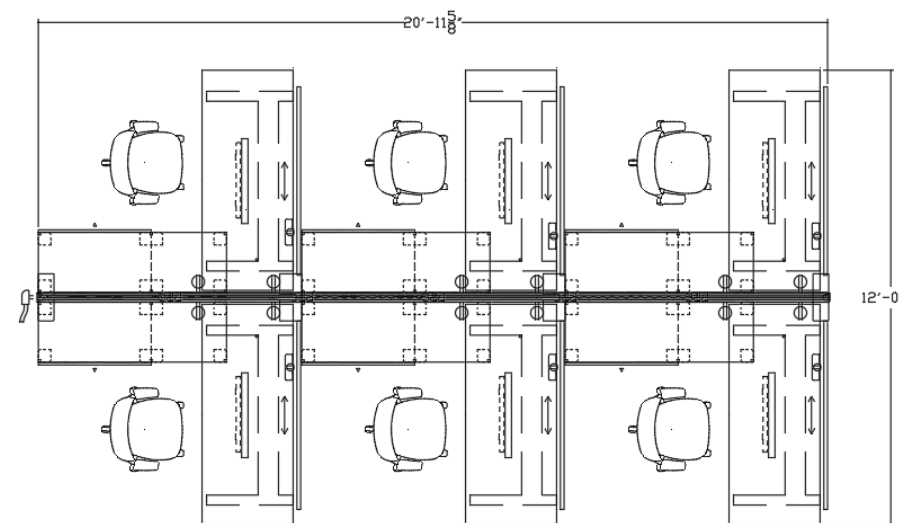

# Knoll: Dividends Horizon, Anchor & k.stand, Typical 4



**Sustainability | Compliance:**

BIFMA Level®, Clean Air GOLD, LEED, FSC, Declare



**Warranty:** 10 Years



**Finishes:**

- [Click here for Dividends brochure](#)
- [Click here for Anchor brochure](#)
- [Click here for k.stand brochure](#)

- [Click here for product price list](#)
- [Click here for product price list](#)
- [Click here for product price list](#)

**Laminates:**



**Paints:**



**k.stand Base Paints:**



**Fabrics:**

- [Click here for approved Textiles](#)
- [Click here to view Textiles](#)

## Knoll: Rockwell Unscripted & Anchor, Typical 5



## Knoll: Rockwell Unscripted & Anchor, Typical 5

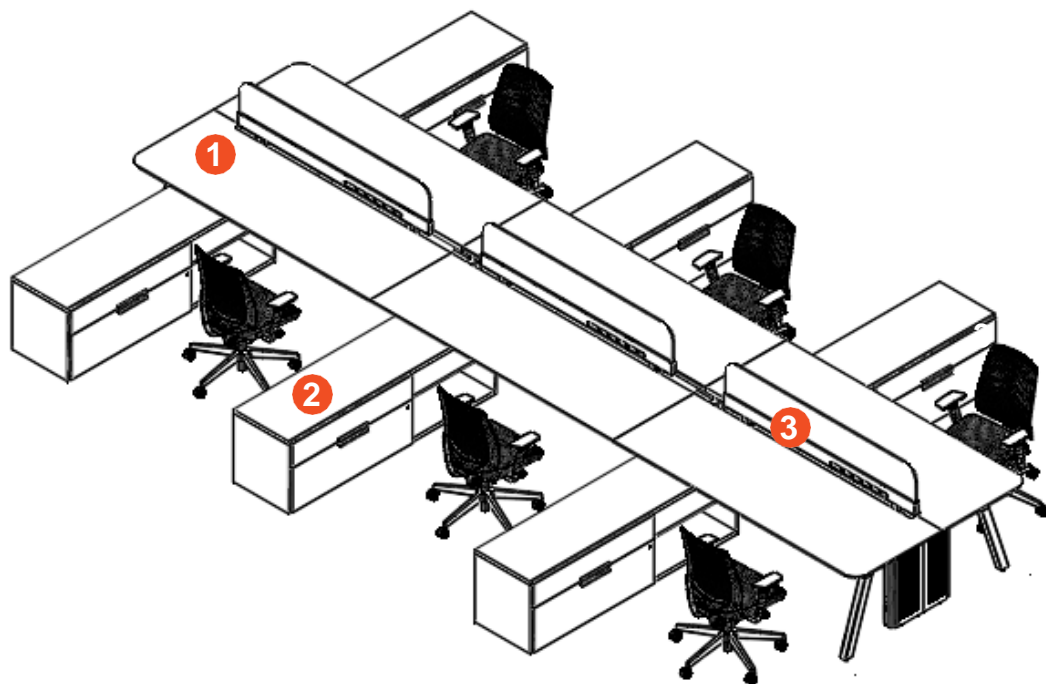

### 1 Workbench

- + Two top styles available - easy or tapered
- + Tapered top has soft-touch painted underside
- + Top is veneer or laminate
- + Legs are solid wood or aluminum with painted steel brackets
- + Three intermediate leg options: tube leg, inset sawhorse leg or standard sawhorse leg
- + Cable towers available
- + Under surface hardwired modular power

### 2 Credenzas

- + Wood construction
- + 100% recycled content particleboard
- + Steel and aluminum components recyclable
- + PVC-free
- + Adhesives and finishes are virtually VOC-free

### 3 Screens

- + Divider screen powered or non-powered with cord set plug strip
- + Available in laminate, veneer, glass and acoustical materials

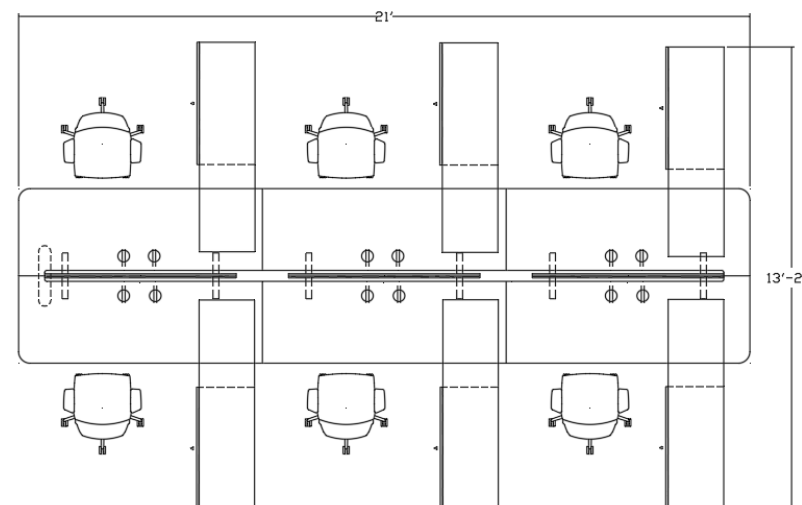



# Knoll: Rockwell Unscripted & Anchor, Typical 5



[Click here for product brochure](#)

[Click here for product price list](#)

[Click here for product brochure](#)

[Click here for product price list](#)

## Finishes:

### Laminates:



### Paints:



### Table Leg:



### Table Edge:

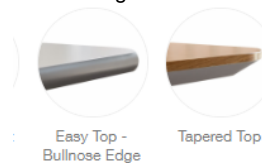

## Sustainability | Compliance:

BIFMA Level®, Clean Air GOLD, LEED, FSC, Declare



**Declare.**

## Warranty:

10 Years



**Knoll:** Antenna & Anchor, Typical 6



## Knoll: Antenna & Anchor, Typical 6

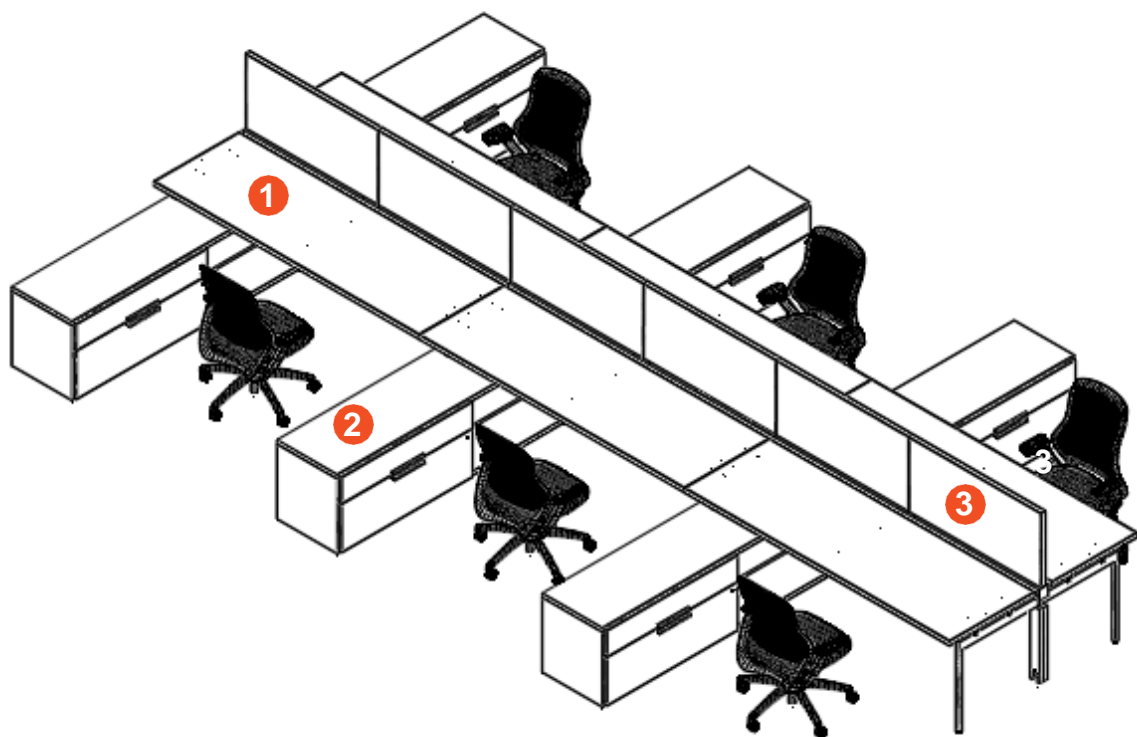

### 1 Desks

- + Various shaped and sizes of worksurfaces available
- + Two leg styles (Desk Legs and Table Desk Legs),
- + Four fixed leg heights and two adjustable height legs
- + Available on casters
- + Linking hardware available

### 2 Credenzas

- + Wood construction
- + 100% recycled content particleboard
- + Steel and aluminum components recyclable
- + PVC-free
- + Adhesives and finishes are virtually VOC-free

### 3 Screens

- + Provide partial enclosure for desks and height-adjustable tables offering seated or standing visual privacy
- + Desk screens attach to the center beam
- + Desk screens can also attach to the rear of the worksurface in two horizons and two modesty heights to provide varying levels of enclosure above or below the worksurface.

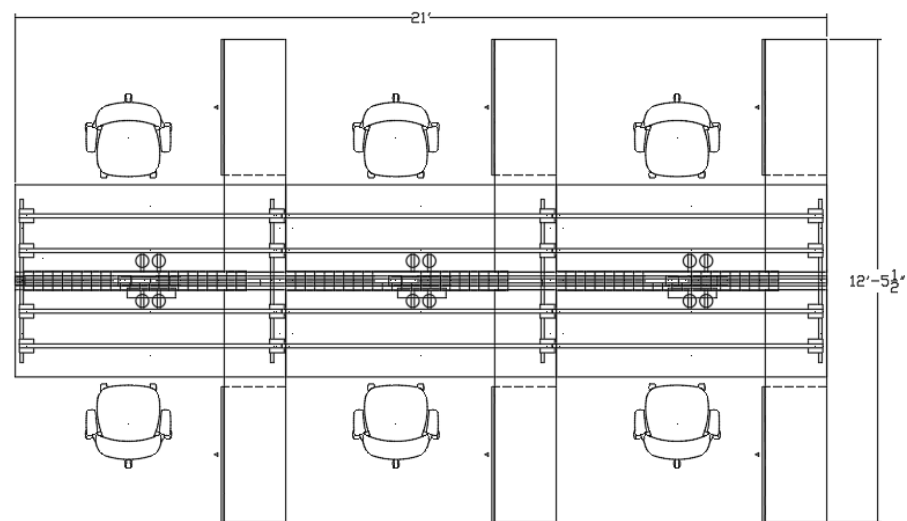

# Knoll: Antenna & Anchor, Typical 6



**Sustainability | Compliance:**

BIFMA Level®, Clean Air GOLD, LEED, FSC, Declare



**Warranty:** 10 Years



[Click here for product brochure](#)  
[Click here for product brochure](#)

[Click here for product price list](#)  
[Click here for product price list](#)

**Finishes:**

**Laminates:**



**Paints:**



**Fabrics:**

[Click here for approved Textiles](#)

[Click here to view Textiles](#)





# Ergonomic Accessories

## Humanscale: M2.1, monitor arm



[Click here for product brochure](#)

[Click here for product price list](#)

### Description:

In today's fast-paced, agile workspace, there's no time for discomfort. Humanscale's next generation monitor arm line instantly personalizes any workstation for improved comfort, health and productivity. Designed for unprecedented adaptability, our monitor arms focus on ergonomics and the use of technology, while featuring ultra-sleek aesthetics.

### Specifications:

- Supports most monitors in use today (up to 20 pounds)
- Interchangeable mounting options attach to a variety of work surfaces
- Integrated cable management hides cables within the arm
- Removable 180° stop protects walls and panels
- Optional Notebook Holder accommodates laptops 9" – 14" in length
- Optional 12" links provide greater adjustability and flexibility

### Dimensions:

- Arm reach: 20"
- Height adjustment range: 10"
- Weight: 5.7 pounds

### Finishes:



Silver with Gray Trim



Polished Aluminum with White Trim



Black with Black Trim

### Sustainability | Compliance:

Greenguard, may contribute to LEED credits



### Warranty:

15 Years, 24/7

## Humanscale: M8.1, monitor arm

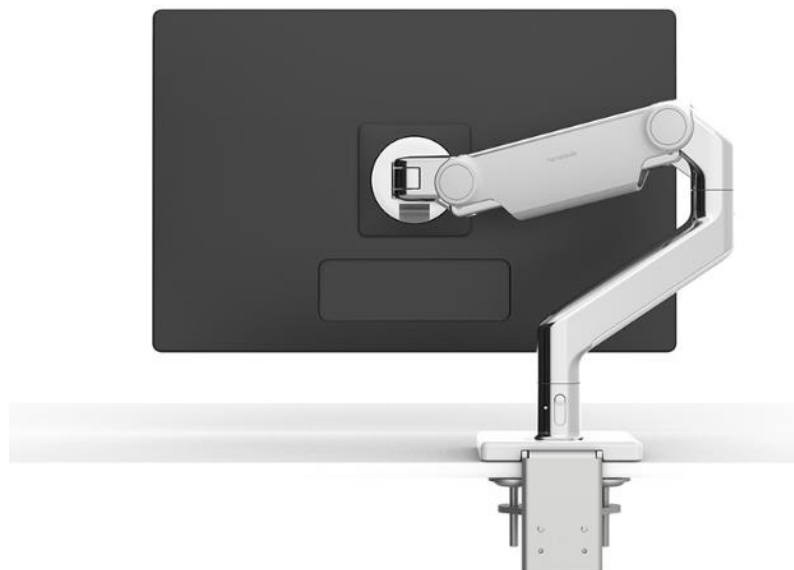

[Click here for product brochure](#)

[Click here for product price list](#)

### Description:

In today's fast-paced, agile workspace, there's no time for discomfort. Humanscale's next generation monitor arm line instantly personalizes any workstation for improved comfort, health and productivity. Designed for unprecedented adaptability, our monitor arms focus on ergonomics and the use of technology, while featuring ultra-sleek aesthetics.

### Specifications:

- Modular design features interchangeable links to accommodate most applications
- Built-in security system provides effective theft-deterrent for public areas
- Humanscale's Quick Release ball joint facilitates fast and easy monitor installation and removal
- Built-in fine-tune adjustment ensures dual monitors line up perfectly
- Optional Notebook Holder accommodates laptops 9" – 14" in length
- Optional 12" links provide greater adjustability and flexibility
- 180° stop mechanism prevents wall damage from over-rotation
- Integrated cable management system hides cable clutter for improved organization and aesthetics

### Dimensions:

- Arm reach: 22"
- Height adjustment range: 11.5"

### Finishes:



Silver with Gray Trim



Polished Aluminum with White Trim



Black with Black Trim

### Sustainability | Compliance:

Greenguard, may contribute to LEED credits



### Warranty:

15 Years, 24/7

## Humanscale: M/Flex, monitor arm



[Click here for product brochure](#)

[Click here for product price list](#)

### Description:

The M/Flex multi-monitor arm system allows the user to simply swap attachments to suit their changing technology needs while retaining a sleek, minimal aesthetic. Manufactured primarily from recycled aluminum, M/Flex is as recyclable as it is beautiful

### Specifications:

- Scalable solution accommodates future additions of up to 6 monitors
- Compatible with Humanscale's M2.1, M8.1 and M10 monitor arms
- Reduces future installation costs by allowing for simple reconfigurations
- Available with accessories such as Notebook Holders, Crossbars, Thin Client Holders, UFEAs, Colored VESA Covers and Sliders
- Patent-pending Smart Stop allows the user to customize the rotation of the arm, preventing overhang and protecting surrounding equipment
- Patent-pending Quick Release Joints instantly snap together for a secure and robust fit, simplifying installation
- Compatible with M/Connect, M/Connect 2 and M/Power, the first-ever integrated monitor arm bases and docking stations of their kind
- Supports up to 100 lbs.

### Dimensions:

- Arm reach: up to 28"
- Height adjustment range: up to 10" dynamic & 30" static

### Finishes:



Silver with Gray Trim

Polished Aluminum with White Trim

Black with Black Trim

### Sustainability | Compliance:

Greenguard, may contribute to LEED credits



### Warranty:

15 Years, 24/7



## Humanscale: M8.1, monitor arm with crossbar & handle

[Click here for product brochure](#)

[Click here for product price list](#)



### Description:

In today's fast-paced, agile workspace, there's no time for discomfort. Humanscale's next generation monitor arm line instantly personalizes any workstation for improved comfort, health and productivity. Designed for unprecedented adaptability, our monitor arms focus on ergonomics and the use of technology, while featuring ultra-sleek aesthetics.

### Specifications:

- Modular design features interchangeable links to accommodate most applications
- Built-in security system provides effective theft-deterrent for public areas
- Humanscale's Quick Release ball joint facilitates fast and easy monitor installation and removal
- Built-in fine-tune adjustment ensures dual monitors line up perfectly
- Optional Notebook Holder accommodates laptops 9" – 14" in length
- Optional 12" links provide greater adjustability and flexibility
- 180° stop mechanism prevents wall damage from over-rotation
- Integrated cable management system hides cable clutter for improved organization and aesthetics

### Dimensions:

- Arm reach: 22"
- Height adjustment range: 11.5"

### Finishes:



Silver with Gray Trim



Polished Aluminum with White Trim



Black with Black Trim

### Sustainability | Compliance:

Greenguard, may contribute to LEED credits



### Warranty:

15 Years, 24/7

## Humanscale: 6G, keyboard tray



### Sustainability | Compliance:

BIFMA Level®



### Warranty:

15 Years



[Click here for product brochure](#)

[Click here for product price list](#)

### Description:

In many ways, a keyboard support is the heart of an ergonomic workstation. As reach and vision drive posture, our keyboard tray allows the user to sit in a healthy, neutral posture through bringing the keyboard and mouse to the user in an ergonomic position.

### Specifications:

- Dial-a-tilt positioning that allows you to type at the angle most comfortable for you
- Ultra-thin profile to provide maximum knee clearance
- Superior design to provide maximum strength and stability yet extremely lightweight
- Raised tilt mechanism to protect the keyboard from collisions with the edge of the desk

### Keyboard Mechanism:

- Tilt adjustment range: 0 to -15 degree
- Made primarily of powder-coated steel

### Keyboard Platform:

- Wide range of keyboard options
- Made of 1/4" phenolic resin
- Durable and slim profile
- Available with Technogel or foam palm supports

### Finishes:



White



Black

# Humanscale: CPU200, CPU holder



[Click here for product brochure](#)

[Click here for product price list](#)

### Description:

AN IDEAL ERGONOMIC WORKSTATION is built with tools that work together to improve the health and comfort of computer users. While products such as task chairs and monitor arms are essential, additional components such as thin clients and CPU holders can further improve workstation ergonomics. Designed to attach under the work surface, our CPU holders eliminate worksurface cable clutter while keeping the device safe and off the floor.

### Specifications:

- Built to accommodate smaller CPU towers
- Fits CPUs 1" - 5" in width and 6" - 12" in height
- Accommodates CPUs up to 15 lbs.
- Under-desk track mount with 360-degree swivel capability
- Made with 48% recycled and 99% recyclable content.

### Dimensions:

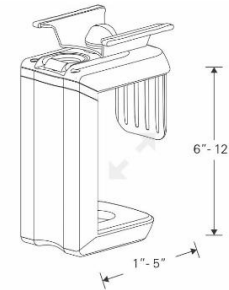

### Finishes:



White/Brushed Aluminum



Black/Brushed Aluminum

### Sustainability | Compliance:

BIFMA Level®



### Warranty:

15 Years

## Humanscale: CPU600, CPU holder



### Sustainability | Compliance:

BIFMA Level®



### Warranty:

15 Years



[Click here for product brochure](#)

[Click here for product price list](#)

### Description:

AN IDEAL ERGONOMIC WORKSTATION is built with tools that work together to improve the health and comfort of computer users. While products such as task chairs and monitor arms are essential, additional components such as thin clients and CPU holders can further improve workstation ergonomics. Designed to attach under the work surface, our CPU holders eliminate worksurface cable clutter while keeping the device safe and off the floor.

### Specifications:

- Built to accommodate larger CPU towers
- Fits CPUs 3.5" - 9" in width and 12"-20" in height
- Accommodates CPUs up to 50 lbs.
- Under-desk track mount with 360-degree swivel capability
- Made with 50% recycled and 99% recyclable content.

### Dimensions:

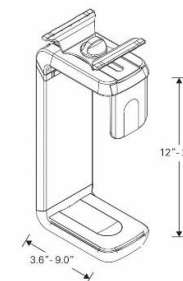

### Finishes:



White/Brushed Aluminum



Black/Brushed Aluminum



## Humanscale: M/Connect 2, dock



[Click here for product brochure](#)

[Click here for product price list](#)

### Description:

M/CONNECT 2 is a next-generation USB docking station that keeps all your devices connected through a single hub of power and data. With a patented split dock design, M/Connect 2 provides multiple connection options beneath the desk while keeping all essential ports above the work surface and conveniently within reach.

### Specifications:

- Universal USB docking station with USB-C, USB-A and Thunderbolt connectivity
- Backwards compatible to USB-A
- 100W power delivery
- Supports 4K video resolution for up to 2 monitors
- Features a total of 11 ports for power and data
- Features two charging ports dedicated exclusively to delivering power, alleviating potential security risks
- Various mounting options available for easy application to any worksurface
- Kensington Security Lock Slot available for both the hub and dock for additional security and theft protection

### Desktop Hub

- 2 USB-A data ports, 1 USB-C charging port, 1 USB-A charging port and 1 3.5 mm Audio/microphone

### Underdesk Dock

- 3 USB-A data ports (1, high charging port), 2 Display Ports and 1 Ethernet Jack

### Finishes:



Silver with gray trim and cables | Polished aluminum with white trim and cables | Black with black trim and cables

### Sustainability | Compliance:

BIFMA Level®





### Warranty:

Limited 3 year

## Humanscale: Element, 790 light



 [Click here for product brochure](#)

 [Click here for product price list](#)

**Description:** The Element 790 task light is Humanscale's response to the need for intelligent workspace lighting. Intuitive and flexible, the Element 790 combines high performance ergonomic design with 360 degrees of adjustability and unprecedented functionality in LED task lamps. A revolutionary task light, the Element 790 delivers the equivalent of light from a 90W incandescent using less than 7W of power.

- Specifications:**
- Power consumption: 5 watts, utilizes only 0.5 watts in lowest setting
  - Color Temperature: 3500K
  - Life: 50,000 hours (L70)
  - ETL, CB Certified
  - RoHS/WEEE compliant

- Dimensions:**
- Maximum reach: 28"
  - Working height: 18"
  - 360° swivel from base
  - 135° front-to-back head tilt
  - 90° side-to-side head rotation

**Finishes:**



Silver (semi-matte)

Arctic White (high gloss)

Jet Black (semi-matte)

**Sustainability  
| Compliance:**

May contribute to LEED credits



**Warranty:**

10 Years

# Tables

A modern office meeting table with four blue chairs in a cubicle setting. The table is light-colored with a dark base. The chairs are blue with grey seats and black bases with casters. The background shows a cubicle with a white shelf and a wooden cabinet. The floor is carpeted.

## Knoll: Dividends Horizon, Rectangular EQ table

[Click here for product brochure](#)

[Click here for product price list](#)



### Description:

Dividends Horizon EQ Tables bring timeless style to a multitude of applications, including collaboration areas in the open plan, break rooms and private offices. Available with round, square, rectangular and oval tops, the same table base can be used across the office to maintain visual consistency throughout the space.

### Specifications:

- + Top: laminate surface with an FSC-certified particle board core
- + Base: Extruded aluminum

### Dimensions:

96W" x 36D" x 29H"

### Finishes:

#### Laminate:



#### Paint:



### Sustainability | Compliance:

BIFMA Level®, Clean Air GOLD, FSC



### Warranty:

Limited Lifetime 10 Years





## Knoll: Dividends Horizon, Round EQ table



[Click here for product brochure](#)

[Click here for product price list](#)

### Description:

Dividends Horizon EQ Tables bring timeless style to a multitude of applications, including collaboration areas in the open plan, break rooms and private offices. Available with round, square, rectangular and oval tops, the same table base can be used across the office to maintain visual consistency throughout the space.

### Specifications:

- + Top: laminate surface with an FSC-certified particle board core
- + Base: Extruded aluminum

### Dimensions:

36W" x 29H"

### Finishes:

#### Laminate:



#### Paint:



### Sustainability | Compliance:

BIFMA Level®, Clean Air GOLD, FSC



### Warranty:

Limited Lifetime 10 Years

## Knoll: Pixel, T-leg rectangular table



[Click here for product brochure](#)

[Click here for product price list](#)

### Description:

The Pixel Collection is designed to create effective learning and training environments, fostering connections and creativity—so people can think, learn and work with ease. Pixel can be used independently or ganged together and comes in five base options. For classrooms and training rooms, dining or office space, Pixel is the ideal solution for active environments.

### Specifications:

- + Fixed or Flip Top work height; pin set or electric height adjustable
- + Multi-purpose trough with magnetic door for easy access to power and data
- + Pixel Connect integral ganging bracket allows table to be ganged on all four sides

### Dimensions:

60W" x 24D" x 28.75H"

### Finishes:

#### Laminate:



#### Paint:



### Sustainability | Compliance:

BIFMA Level®, Clean Air GOLD



### Warranty:

Limited Lifetime 10 Years



## Knoll: Pixel, C-leg rectangular flip-top table



### Sustainability | Compliance:

BIFMA Level®, Clean Air GOLD



### Warranty:

Limited Lifetime 10 Years



[Click here for product brochure](#)

[Click here for product price list](#)

### Description:

The Pixel Collection is designed to create effective learning and training environments, fostering connections and creativity—so people can think, learn and work with ease. Pixel can be used independently or ganged together and comes in five base options. For classrooms and training rooms, dining or office space, Pixel is the ideal solution for active environments.

### Specifications:

- + One-handed flip and easy nesting
- + Multi-purpose trough with magnetic door for easy access to power and data
- + Pixel Connect integral ganging bracket allows table to be ganged on all four sides

### Dimensions:

60W" x 24D" x 28.75H"

### Finishes:

#### Laminate:



#### Paint:



## Knoll: K.stand, height adjustable table



### Sustainability | Compliance:

BIFMA Level®, Clean Air GOLD, Declare, FSC



### Warranty:

5 Years



 [Click here for product brochure](#)

 [Click here for product price list](#)

### Description:

k. Stand is a collection of height-adjustable bases, worksurfaces and accessories that are easy to specify and use. k. stand responds to the needs of today's office by scaling to create adaptable spaces that support many work modes among diverse work groups and in all areas of the workplace.

### Specifications:

- + 265 lb. lifting capacity
- + Meets UL 962 for table assembly
- + Dual and Triple motors
- + Dual rated electrical for global use
- + Standard collision detection

### Dimensions:

60W" x 30D"

### Finishes:

#### Laminate:



#### Base:





# Whiteboards

A modern office lounge featuring a large, blank whiteboard mounted on a dark grey wall. The room is furnished with several bright yellow armchairs arranged around a small, round white table. A blue floor lamp stands to the left, and a blue decorative object sits on the table. The overall aesthetic is clean and professional.

## ASI: Whiteboards



 [Click here for product information](#)

### Description:

The performance of ASI Glass Markerboards is unmatched in the industry, allowing designers and architects the ability to showcase interiors with this striking product line. Its clean lines and superior erasability are achieved using only ASI's UltraClear™, 1/4" tempered glass, also known as museum glass. ASI Markerboards may be optionally specified with a backing that allows for magnetic applications when used with rare earth magnets.

### Specifications:

#### Glass

- All glass tempered
- Sizes up to 82" x 142"
- 1/4" low iron tempered UltraClear™ glass
- Custom graphics available
- Optional magnetic backing

#### Porcelain

- Lifetime warranty (*on writing surface for the life of the building*)
- Can be written on with dry-erase markers
- Optimum erasability—and easy to maintain
- Scratch, bacteria, chemical, and fire resistant—will not combust or release toxic fumes in the event of fire
- Greater color contrast
- Standard is high gloss white
- Premium color finishes available
- Colorfast—will not fade
- Safe and clean—releases no harmful chemicals into the environment

### Dimensions:

Sizes:	4' x 3'	4' x 4'	4' x 6'	4' x 8'	4' x 10'	4' x 12'	5' x 3'	5' x 4'	5' x 6'	5' x 8'	5' x 10'	5' x 12'
Porcelain	■	■	■	■	■	■	■	■	■	■	■	■
Glass	■	■	■	■	■	■	■	■	■	■	■	■

### Sustainability | Compliance:

May contribute to LEED credits





# High Density Storage

## SpaceSaver: High Density Storage



 [Click here for product information](#)

### Description:

A tailored storage system that meets your unique criteria. Single-sourced, turnkey project management. Factory-certified system installation. A nationwide sales network with ongoing local maintenance and support.

With over 100,000 installed systems – more than all of our competition combined – Spacesaver leads the industry in customized, high-density mobile storage solutions. Almost any type of material – regardless of its size, weight or shape – can be stored in Spacesaver Powered Systems. Designed to maximize your storage space, they often more than double storage capacity in the same floor space. They also provide an extraordinary level of quality, as our ISO 9001 certification attests.

### Finishes:

#### Paint:



#### Laminate:





Outdoor





## Canaan Site Furnishings: Outdoor Furniture



 [Click here for product catalog](#)

### Description:

Canaan is aware of how much product functionality and durability value for outdoor furniture. All of our site furniture is crafted by the hands of seasoned technicians. We also recognize the significance of sustainable development. From benches and tables to bins and bike racks, we are working on reducing as many footprints on the planet as we can through the products we offer.

### Finishes:

#### Standard Colours - Gloss:



#### Specialty Colours - Matte:

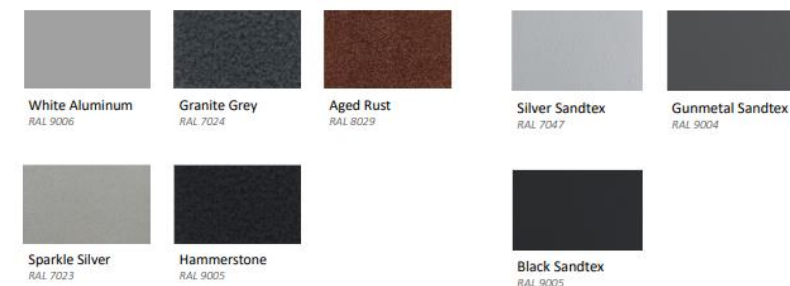

# Architectural Walls

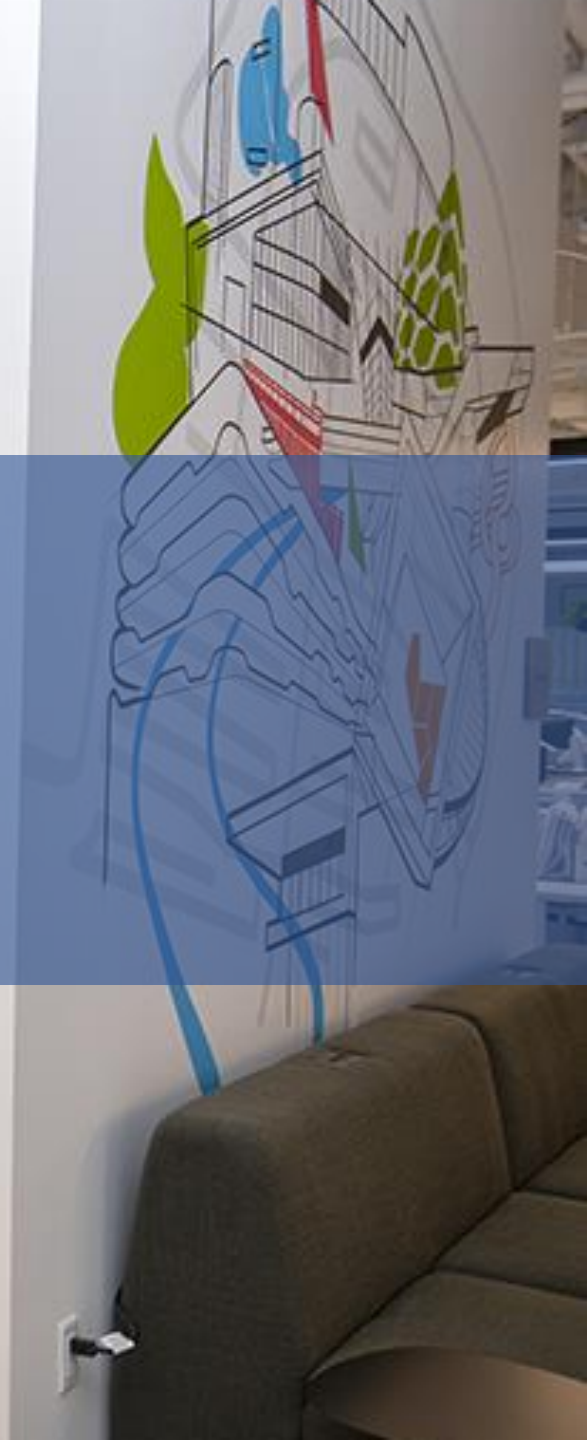



## Mywall: Architectural Walls



 [Click here for more information](#)

### Description:

Mywall architectural walls offer a diverse and unique product offering that affords any client or designer virtually unlimited possibilities, from ultra slim profiles to substantial double glass extrusion walls combined with elegant tertiial pivot doors or German engineered soft close sliders. Hardware is machined brushed stainless steel.

### Specifications:

- + Available in various styles: H5T, H5, H5 Solid & HT
- + Tempered Glass: 10mm & 12mm
- + Laminated Glass: 10mm & 12mm

 [Click here for door information](#)

 [Click here for hardware information](#)

 [Click here for door & hardware compatibility matrix](#)

### Finishes:

#### Standard Aluminum Finishes:



#### Standard Laminate Finishes:

